

nord lead A1
analog modeling synthesizer

nord lead A1R
analog modeling synthesizer

User Manual
Nord Lead A1
Nord Lead A1R
OS Version 1.3x



CAUTION: TO REDUCE THE RISK OF ELECTRIC SHOCK DO NOT REMOVE COVER (OR BACK). NO USER SERVICEABLE PARTS INSIDE. REFER SERVICING TO QUALIFIED PERSONNEL.

ATTENTION: POUR EVITER LES RISQUES DE CHOC ELECTRIQUE, NE PAS ENLEVER LE COUVERCLE. AUCUN ENTRETIEN DE PIECES INTERIEURES PAR L'USAGER. CONFIER L'ENTRETIEN AU PERSONNEL QUALIFE.

AVIS: POUR EVITER LES RISQUES D'INCIDENTE OU D'ELECTROCUTION, N'EXPOSEZ PAS CET ARTICLE A LA PLUIE OU L'HUMIDITET.



The lightning flash with the arrowhead symbol within an equilateral triangle is intended to alert the user to the presence of uninsulated voltage within the products enclosure that may be of sufficient magnitude to constitute a risk of electric shock to persons.

Le symbole éclair avec le point de flèche à l'intérieur d'un triangle équilatéral est utilisé pour alerter l'utilisateur de la présence à l'intérieur du coffret de "voltage dangereux" non isolé d'ampleur suffisante pour constituer un risque d'électrocution.



The exclamation mark within an equilateral triangle is intended to alert the user to the presence of important operating and maintenance (servicing) instructions in the literature accompanying the product.

Le point d'exclamation à l'intérieur d'un triangle équilatéral est employé pour alerter l'utilisateur de la présence d'instructions importantes pour le fonctionnement et l'entretien (service) dans le livret d'instructions accompagnant l'appareil.

Instructions pertaining to a risk of fire, electric shock or injury to persons.

IMPORTANT SAFETY INSTRUCTIONS SAVE THESE INSTRUCTIONS

Warning - When using electric products, basic precautions should always be followed, including the following:

- 1) Read these instructions.
- 2) Keep these instructions.
- 3) Heed all warnings.
- 4) Follow all instructions.
- 5) Do not use this apparatus near water.
- 6) Clean only with dry cloth.
- 7) Do not block any ventilation openings. Install in accordance with the manufacturer's instructions.
- 8) Do not install near any heat sources such as radiators, heat registers, stoves, or other apparatus (including amplifiers) that produce heat.
- 9) Do not defeat the safety purpose of the polarized or grounding-type plug. A polarized plug has two blades with one wider than the other. A grounding type plug has two blades and a third grounding prong. The wide blade or the third prong are provided for your safety. If the provided plug does not fit into your outlet, consult an electrician for replacement of the obsolete outlet.
- 10) Protect the power cord from being walked on or pinched particularly at plugs, convenience receptacles, and the point where they exit from the apparatus.
- 11) Only use attachments/accessories specified by the manufacturer.
- 12) Use only with the cart, stand, tripod, bracket, or table specified by the manufacturer, or sold with the apparatus. When a cart is used, use caution when moving the cart/apparatus combination to avoid injury from tip-over.
- 13) Unplug this apparatus during lightning storms or when unused for long periods of time.
- 14) Refer all servicing to qualified service personnel. Servicing is required when the apparatus has been damaged in any way, such as power-supply cord or plug is damaged, liquid has been spilled or objects have fallen into the apparatus, the apparatus has been exposed to rain or moisture, does not operate normally, or has been dropped.



Additional Safety Information

No naked flame sources, such as lighted candles, should be placed on the apparatus;

Do not use the apparatus in tropical climates.

WARNING: To reduce the risk of fire or electric shock, do not expose this apparatus to rain or moisture.

The apparatus shall not be exposed to dripping or splashing and that no objects filled with liquids, such as vases, shall be placed on the apparatus.

The mains plug is used as the disconnect device and shall remain readily operable.

Il convient de ne pas placer sur l'appareil de sources de flammes nues, telles que des bougies allumées;

L'appareil n'est pas destiné à être utilisé sous un climat tropical.

L'appareil ne doit pas être exposé à des égouttements d'eau ou des éclaboussures et de plus qu'aucun objet rempli de liquide tel que des vases ne doit être placé sur l'appareil.

Lorsque la prise du réseau d'alimentation est utilisée comme dispositif de déconnexion, ce dispositif doit demeurer aisément accessible.

Trademarks: The Nord logo is a trademark of Clavia DMI AB. All other trademarks mentioned in this publication are the properties of their respective holders.

Specifications and appearances are subject to change without notice.

Copyright © Clavia DMI AB



Intertek

Nord Lead A1 User Manual

1 Introduction

The Lead For Speed	5
2 models - keyboard and tabletop.	5

2 Overview

The Panel	6
Oscillator, Filter & Amp Env	6
Modulation.	6
Effects and Output.	6
Voice Mode	6
Pitch Stick	6
Mod Wheel	6
Arpeggiator	6
Program and Performance	6
Morph	6
Editing	7
Buttons	7
On/Off buttons	7
Selector buttons	7
Shift button	7
Master Clock (Mst Clk)	7
Knobs & dials	7
Knobs	7
Knobs with Shift features	7
Dials	7
Master Level	7
Rear Panel	8
Audio Connections	8
Headphones	8
1, 2, 3 & 4 Outputs.	8
General guide on audio connections	8
MIDI Connections	8
MIDI OUT	8
MIDI IN	8
USB Connection	8
USB MIDI	8
Pedal Connections	8
Sustain pedal	8
Control pedal	8

3 Getting Started

Slots	9
Selecting a Program	9
Editing a Program	9
Storing a Program	9
Layering Programs.	9
Soloing a Slot.	9
Multi Focus	9
Creating a Split	10
Setting the Split point.	10
Working with Performances.	10
Selecting Performances.	10
Editing a Performance	10
Storing a Performance.	10
Storing Programs as a Performance	10
Setting up a Morph	10

4 Slots and Memory

General Overview	11
Slot Handling	11
Split	11
Solo	11
Multi Focus	11
Program Handling	12
Programs	12
Performances	12
Performance Mode	12
Loading	12
Storing	12
Copying Slots to a Performance	12
Copying a Performance to Program	12

5 Morph

Morphing	13
The Morphs	13
Wheel/Control Pedal	13
Velocity	13
Assign a Morph source to a parameter	13
Morph parameters	13
Editing Morphs	14
Morph Programming Latch	14

6 Mutator, Randomize & Like

Mutator	15
Executing the Mutation	15
Randomize	15
Mutate Morph	15
Like	16
Program Likes	16
Performance Likes	16
Select a Like to Store	16

7 Panel Reference

Master Level	17
MIDI LED	17
Morph	17
Program/Value Dial	17
LED Display	17
Performance Mode/Execute	17
Store	17
Copy/Monitor	17
Paste	17
Slot A - D	18
Deactivate a Slot	18
Panel Focus	18
Multi Focus	18
Soloing a Slot.	18
Incoming MIDI	18
System - MIDI - Sound	18
Master Clock	18
Octave Shift	18
Keyboard Octave Shift.	18
Split	18
Setting the Split point.	18

Hold	18
Hold Enable	18
Shift/Exit	18
Pitch Stick	18
Modulation Wheel	19
Arpeggiator	19
Arpeggio Run.	19
Arpeggio Rate	19
Arpeggio Mst Clk.	19
Arpeggio Range.	19
Arpeggio Directions	19
Panic	19
Voice Mode	19
Unison	19
Mono	19
Legato	19
Glide	19
Multi Focus	19
Bend Range	19
Vibrato	19
Init Sound	19
Low Frequency Oscillator (LFO/ENV)	20
Rate/Time	20
LFO Master Clock (Mst Clk)	20
LFO Waveform Selector.	20
Envelope	20
LFO Modulation Polarities	20
Modulation Envelope	20
Attack	20
Decay	20
Release	20
Inverted Envelope	21
Env Vel.	21
Oscillators	21
Panel Analog Waveforms	21
Extended Analog Waveforms.	21
Fixed Pulse Waveforms	21
Drawbar Organ Waveforms	21
Bells and Tines	21
Digital.	22
Electric.	22
Formants	22
Oscillator Configuration	22
Single Oscillator Configurations	22
Pitch	22
Shape	22
Sync	22
Dual Oscillator Configurations	22
Detune	22
Sine, Tri, Saw and Pulse Mix	23
Modulation Configurations.	23
FM (Frequency Modulation)	23
AM (Amplitude Modulation)	23
Amp Envelope	23
Attack	23
Decay	23
Release	23
Env Vel.	23
Filter	24
Filter Frequency (Freq)	24
Filter Resonance	24
LFO Amount	24
Modulation Envelope Amount	24
Keyboard Tracking (KB Track)	24
Drive	24
Filter Type	24

LP 12, 24	24
LP M	24
LP TB	25
BP	25
HP	25
FX	25
Flanger	25
Phaser	25
RM	25
Chorus	25
Ensemble	25
Drive	25
Mutate Sound	25
Delay	25
Tempo	25
Tap Tempo	26
Mst Clk	26
Feedback	26
Ping Pong	26
Sound Menu Delay Mode	26
On/Off	26
Randomize Sound	26
Output	26
Level	26
Pan	26
Reverb	26
Dry/Wet	26
Reverb Select	26
On/Off	26
Like	26
Note Trig (Nord Lead A1R)	26

8 Master Clock

Master Clock	27
External Sync	27
Arpeggio with Mst Clk	27
Synced Delay repeats	28
Sync the LFO	28
Across the Slots	28
Sound Menu Kbd Sync	28

9 Nord Sound Manager

System requirements	29
---------------------	----

10 The Menus

System Menu	30
1 - Memory Protect	30
2 - Transpose	30
3 - Fine Tune	30
4 - Sustain Pedal Polarity	30
5 - Wheel Mode	30
6 - Ctrl Pedal Mode	30
7 - Ctrl Pedal Type	30
8 - Ctrl Pedal Gain	30
9 - Mutator Protect	30
A B C D - Slot Output Routing	30
MIDI Menu	31
G - Global MIDI Channel	31
A, B, B, D - Slot MIDI Channel	31
t - Soft Thru MIDI Channel	31
1 - Local Control	31
2 - Control Change (CC) Mode	31
3 - Program Change Mode	31
4 - Pitch Bend Mode	31
5 - Send CC	31
6 - Dump One	31
7 - Dump Program Bank	31
Sound Menu	31
1 - Mst Clk Kbd Sync	31
2 - Delay Mode	31
3 - Vibrato Rate	31
4 - Vibrato Amount	31

11 MIDI

Nord Lead A1 MIDI operation	32
MIDI Settings	32
Global MIDI Channel	32
Slot MIDI Channels	32
Sequencing: Global MIDI Channel	32
Recording parameter changes	32
Sequencing: Slot MIDI Channels	32
Control Slots with another keyboard	33
Message types	33
Program Changes and Bank Select	33
Control Change messages	33
Pedal Control Change	33
Volume	33
Pan CC	33
MIDI Local	33
MIDI Thru	33
MIDI Clock	33
USB MIDI	33
Panic	33
MIDI Dumps	33
Transmit settings	33
Receive Programs or Banks	33
MIDI Controller list	34
MIDI Implementation Chart	35

12 Appendix

Specifications	36
Display Messages	37

13 Index

Index	38
--------------	----

1 Introduction



The Lead For Speed

Producing stand-out sounds for live or for the studio, the Lead A1 is ideal for all musical genres. Thanks to its carefully thought-out user interface, the Lead A1 encourages experimentation, allows for far speedier programming than would otherwise be possible, and ultimately delivers sensational sonic results.

Our best-ever analog modeling ...

At the heart of the Lead A1 is our new analog modeling engine. Taking our virtual analog synthesis to a new level, this modeling recreates a total analog signal path with uncanny realism, and is capable of immense sonic variety. With a 26-voice polyphony and four simultaneous synthesizer parts, the Lead A1 is a true synthesizer powerhouse that goes far beyond the current trend for limited capability analog reissues.

... combined with our most intuitive interface

Fundamental to the design of the Lead A1 is a brand new simple yet sophisticated front panel interface. The Lead A1 allows easy patch creation and experimentation thanks to a new and unique oscillator section, pre-programmed modulation matrix, and simplified ADR/ASR envelopes.

Like-button

The Like function is a unique feature that is invaluable during the patch creation process. “Like” up to 50 versions of a patch as you design it, scroll between them to choose your favorite to save to actual memory, or go back to an earlier version to edit in a different way.



Sound Manager

The Lead A1 is compatible with the Nord Sound Manager application for OS X and Windows. Sound Manager is a dedicated librarian that allows for easy reorganizing, back-up and transfer of programs.

Hardware

Like all Nord keyboards the Lead A1 is handmade in Nord's Stockholm factory with incredible attention to detail and quality control. The Fatar® 49-key keybed (keyboard version only), all-metal chassis, tactile knobs, and unfaltering emphasis on quality complete a synthesizer designed to last a lifetime.

2 models - keyboard and tabletop

The Nord Lead A1 comes either as a 49-key velocity sensitive keyboard with a modulation wheel and wooden pitch stick, or as a tabletop unit - the Nord Lead A1R. It has 4 line level outputs, 1 headphone output, MIDI IN & OUT, a USB port with MIDI capabilities and inputs for a sustain pedal and a control pedal.

2 Overview



The Panel

We will familiarize ourselves briefly with the controls on the panel here.

1 Oscillator, Filter & Amp Env

The Lead A1's new Oscillator section generates 47 different waveforms from classic analog to digital harmonic and inharmonic waves, whilst unique Oscillator Configuration Shortcuts make programming more immediate than ever. Start with a single Oscillator waveform and select an Oscillator Configuration Shortcut - Pitch, Detune, Shape, Sync, Sub Mix, FM, AM or Noise - and use the Adjust knob to adjust the settings of the configuration.

The Lead A1's filter section features classic 12 and 24 dB Low Pass, a High Pass and a Band Pass filter, together with stunning emulations of the diode and ladder filters from the legendary Mini and the TB-303 synthesizers. The Lead A1's modeling of these filters capture the true character and response of the originals, allowing supremely flexible and precise sound design.

2 Modulation

The Lead A1 features an LFO with a choice of waveforms and a three-stage ADR/ASR Modulation Envelope. The LFO rate can be sync'd to the Lead A1's master clock. The Mod Envelope can be inverted. Thanks to the intuitive design of the front panel it is very easy to see what modulations have been applied and to design incredible sounding patches.

3 Effects and Output

The Lead A1's effects section features two stunning brand new analog models of an Ensemble and Chorus, modeled from specific vintage synths and adding classic warmth and analog feel. Alongside these, choose from great-sounding Ring Modulation, Phaser, Flanger, or Drive per slot, and in addition a separate Delay and Reverb for each slot.

4 Voice Mode

The Voice Mode Unison parameter can be used to stack several voices on top of each other to create a fatter sound. Mono and Legato are two monophonic behaviors.

5 Pitch Stick

The Pitch Stick is used to bend the notes, with different ranges for each program if you like. There is no dead centre in the middle of the throw. This allows you to use the Pitch Stick for natural vibrato, pretty much like a guitarist do. The effect on pitch is logarithmic, that is, the further you move the Pitch Stick away from the centre position, the more drastic the effect.

6 Mod Wheel

Use the Mod Wheel to add vibrato and act as a Morph controller to change parameters in real time.

i Physical Pitch Bend and Mod Wheel controls are not available on the Nord Lead A1R but it will have an identical performance as the keyboard model when it responds to incoming MIDI Pitch Bend and Mod Wheel messages.

7 Arpeggiator

The Lead A1 features four separate Arpeggiators with Up/Down and Random modes and a 4-octave range. Arpeggios can be synchronized to the Lead A1's master clock.

8 Program and Performance

The Program Dial and its associated LED display is used to load individual programs or performances that can consist of up to 4 individual slots, each with its own sound.

9 Morph

A classic Nord feature, the Morph function allows you to control multiple parameters of the Lead A1 simultaneously via Mod Wheel, Velocity or pedal. Morph is exceptionally easy to set-up and use - just hold the Morph button and adjust any desired knob.

Editing

Grab a knob or press a button, it is that easy to change a sound in the Nord Lead A1. There are a few different types of buttons, and some of the controls change their behavior depending on overlying modes that may be activated. Let's look at some of the things you will find and work with on the panel.

Buttons

On/Off buttons

On/Off buttons are used for activating a parameter or a group of parameters such as effects. The LED next to them indicates the On or Off status.



Selector buttons

Selector buttons are used to activate a setting in an array of two or more. Selector buttons have a set of round or triangular LEDs to indicate the current setting. Press the button several times to cycle through the possible options.

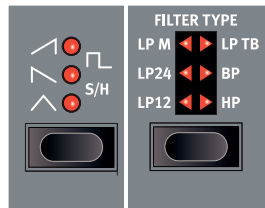

Shift button

Quite a few buttons have a secondary function, which will be available if you hold down Shift while pressing the button. The name of the secondary function is printed below the button. Pressing Shift and Filter Type for example will select one of the Filter Keyboard Tracking settings.

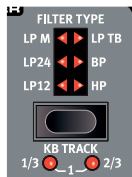

Master Clock (Mst Clk)

The Master Clock button (Shift + Slot D) can be used to set a tempo in two different ways: by holding the button and turning the Program Dial, or by tapping the button in the tempo you wish to use.



Knobs & dials

Knobs

The knobs control the continuously variable parameters in the Nord Lead A1.



A parameter value can be totally different from the knob's physical position when you load a program. As soon as you start turning the knob, the value will 'snap' to the knob's physical position. Most of the knobs have a green LED indicator below them. This LED indicates when a parameter is connected to a Morph source. Look at page 13 for more information on morphing.

Knobs with Shift features

There are a few knobs with Shift-features that are activated by holding Shift and turning the knob. This is used to for example, set the panning of the sound. These knobs have the parameter name in a black box with a LED next to it.



Dials

There are three endless dials, each accompanied by an LED display. One of these dials allows you to change programs and performances, the other changes oscillator parameters.



Master Level

The Master Level knob at the upper left on the panel controls the overall amplitude for the audio outputs, the line level outputs and headphone output. The Master Level knob's actual position always indicates the output level.



i Master Level is not stored in programs or performances.

Rear Panel



Audio Connections

Headphones

A 1/4" stereo connector for headphones.

- ⚠ *Playing at a high volume level can result in hearing impairments such as permanent hearing loss.*
- ❗ *Only Slots that are routed to outputs 1 & 2 are present at the headphone output.*

1, 2, 3 & 4 Outputs

Unbalanced line level outputs with 1/4" connectors to connect the Nord Lead A1 to an sound system or recording equipment.

General guide on audio connections

- Make all the connections before you turn on the power of your amplifier.
- Turn **on** the power of your amplifier **last**.
- Turn **off** the power of your amplifier **first**.

The routing of the audio signals to the outputs are made in the System Menu.

MIDI Connections

MIDI OUT

MIDI connection used for transmitting MIDI from the Nord Lead A1 to other units such as sound modules, sequencers or computers.

MIDI IN

MIDI connection used to receive MIDI from other units such as keyboards, sequencers and computers.

USB Connection

The USB connection connects the Nord Lead A1 to a personal computer. The computer can run the Nord Sound Manager application or be used if the Nord Lead A1 operating system needs to be updated.

USB MIDI

The USB connection on the Nord Lead A1 can also transmit and receive MIDI messages.

- ⚠ *Computers running Microsoft Windows operating systems need a driver for the USB connection to function. The driver can be found at the Nord web site in the Download area.*

Pedal Connections

There are two pedal inputs; one for a sustain pedal and one for a control pedal.

Sustain pedal

1/4" connector for a switch type pedal. When a connected pedal is operated, the notes you play will be sustained.

Two kinds of pedal polarities can be used, open or closed. Select the type that applies to your sustain pedal, in the System menu.

Control pedal

1/4" stereo connector for continuous pedals (also know as expression pedals). This can be used as a source for the Morph function or to control the overall volume.

An expression pedal connected to to the Control Pedal input, must use a stereo connector (Tip-Ring-Sleeve).

The most common pedal models (Roland, Yamaha, Korg and Fatar) are pre-configured in the Nord Lead A1. Select the type of pedal that you use in the System menu.

3 Getting Started

Slots

The Nord Lead A1 has four Slots labelled A, B, C and D. Each slot represents a complete synthesizer setup, a program. Slots can be used for layering sounds or quickly switch between programs.

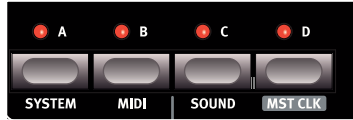

Selecting a Program

1 Press the Perf Mode button so that the Perf Mode LED is not lit. You are now in (single) Program mode, the Slot LEDs will be red.



- 2 Press Slot A, its LED should be the only Slot LED lit. If not, deselect the other Slots by holding A while pressing the other Slot buttons.
- 3 Play on the keyboard and listen to the sound. Turn the Program Dial when you want to select a different program.

Editing a Program

Editing a program is just as easy as turning a knob or pressing a button.

- 1 Select the Slot to be edited.
- 2 Play on the keyboard, listen and change the sound parameters.

Editing will not destroy the original program. To retrieve the original program, just turn the Program Dial first one step back and then one step forward. To keep changes you have made, you have to store the program in the memory.

When you have changed any setting in a program, a dot (.) will appear in the display to the right of the program number. This is to alert you of the fact that the program have been changed but not yet stored.

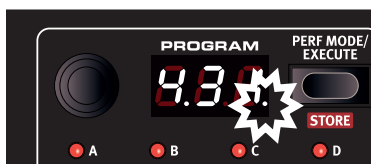

Storing a Program

If you are happy with an edit that you have made, you should probably store the program. Before you can do this for the first time, there is a Memory Protect function that is set to On when the Lead A1 leaves the factory. This needs to be turned Off in the System Menu before you (and your cat) can store anything.

- 1 Hold Shift and press the System button. Turn the Program Dial to select the first setting - "1.0n".
- 2 Hold Shift and turn the Program Dial to select "1.0F", exit the Menu by pressing Exit.

With the protection turned off, we can now store our edited program.

- 3 Hold Shift and press Store. The display starts flashing.
- 4 If you want to overwrite the original program number, just press Shift + Store a second time. To Store to another program number, select a new location with the Program Dial and then press Shift + Store a second time. Your edited program has now replaced the previous one in the location you specified. To cancel the store procedure, press any buttons on the panel.

💡 When searching for a new program location, there is a pre-listening feature that can prevent you from overwriting your favorite programs.

Layering Programs

- 1 Press and hold the Slot A button and then press the Slot B button. Both the Slot A and B LEDs are lit and both programs will be active on the keyboard.

If you have a layer, it is the focused Slot with its LED blinking that will be edited. The blinking Slot LED indicates the Slot in focus.

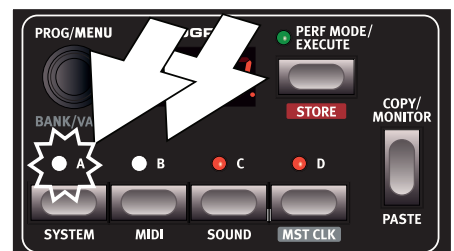

- 2 Press the other Slot button to move the focus to the other Slot.
- 3 Hold Slot A and press again on Slot B. This will deactivate Slot B.

Soloing a Slot

Since a performance may be using up to 4 different programs at once, there is a Solo function available, to be able to listen to only one Slot. Double-tap on an active Slot button in a multi-slot selection to solo this Slot. Press on any of the Slot buttons to exit.

Multi Focus

All parameters can be changed on all active Slots in a layer at the same time. This is called Multi Focus and is activated by holding Shift and pressing the Multi Focus button. All the active Slot LEDs will start to flash, and all Slots will then respond to any parameter changes you make on the panel. Press Multi Focus again to exit.

Creating a Split

When the Split function is ON, the lower part of the keyboard plays on Slots A and B and the upper part on Slots C and D.

- 1 Hold Slot A and press Slot C to activate both these slots.
- 2 Hold Shift and press Split. This splits the keyboard in two halves. Slots A and B will be to the left, Slots C and D to the right.

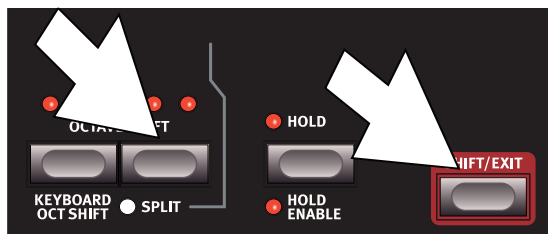

Setting the Split point

Hold Shift and press and hold the Split button. A note number will be indicated in the display. While still holding the buttons, play a key on the keyboard, this key will be the lowest key of the upper range.

Copy and Paste between Slots

Settings from one Slot can be copied to a virtual clipboard and then be pasted to another Slot. This can be useful if a program needs to be moved from the lower part (A and B) to the upper part (C and D).

- 1 Hold Copy and press the source Slot button. "CP" and a letter that indicates which Slot you have copied will be shown in the display.
- 2 Hold Shift + Paste, and press the Slot button where you want your settings to be copied to. "PS" and the destination Slot will be shown in the display.

The content of the virtual clipboard will remain until you copy another setting or parameter, or turn off the Nord Lead A1. This makes it possible to paste the same data to several destinations.

- If you want to keep the new settings you have created by copying, make sure to save the program or performance.

Working with Performances

To handle layers, splits on/off, split points and keyboard octave shift, there is a need for storing and loading complex scenarios. This is done with the Performance Mode function.

In Performance Mode, all slots and their active status are stored.

Selecting Performances

- 1 Press the Perf Mode button to select the Performance Mode.
- 2 Turning the Program Dial will scroll through the 200 performances, "A. 1" to "d.50". As you will notice, some of the performances are made with several Slots on top of each other, others are in split configurations with different sounds to either side of the keyboard.



Editing a Performance

To replace one of the programs in a performance, hold the Slot button with the program you wish to replace and turn the Program Dial.

Storing a Performance

Storing a performance uses the same procedure as storing programs, see page 9.

Storing Programs as a Performance

If you have made layers or splits in Program Mode, you can transfer this to a Performance during the Store process.

- 1 Hold Shift and press Store. The display starts flashing.
- 2 Press Perf Mode to activate Performance Mode.
- 3 Select the desired Performance location and press Shift + Store a second time.

Setting up a Morph

The Morph is a powerful method to control one or several parameters in real-time, with the Modulation Wheel or Keyboard Velocity. A Morph is very easy to set up.

- 1 Hold one of the Morph buttons, let's use the Wheel in this example.
- 2 While holding the Wheel Morph button, turn a parameter knob, like the Filter Freq.
- 3 Release the Morph Wheel button. The Modulation Wheel can now be used to control the filter frequency.



- The range that the Morph (Modulation Wheel) controls will be the range that was set when you turned the Filter Freq knob.

Read more about Morphing on page 13.

4 Slots and Memory

General Overview

The Nord Lead A1 is a four part multi timbral synthesizer. This means that you have four independent synthesizers to be used simultaneously. The synthesizers are divided into Slots, where each Slot contains one synthesizer. The Slots are called A, B, C and D.

The panel shows and edits the features of one Slot at a time. Which Slot that is edited is determined by the Slot focus.

A Slot can either be active or not. All active Slots respond to keyboard input as shown in Figure 1. If several Slots are active it is called a layer.

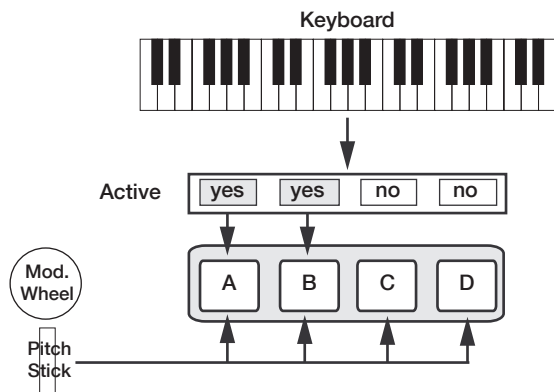

All active Slots respond to keyboard input. Modulation Wheel, Pitch Stick and Control Pedal always reach all slots.

Each of the Slots can listen to different MIDI channels and respond to different keyboard zones. Pitch Stick, Modulation Wheel and Control Pedal reaches all Slots regardless of focus and their active state.

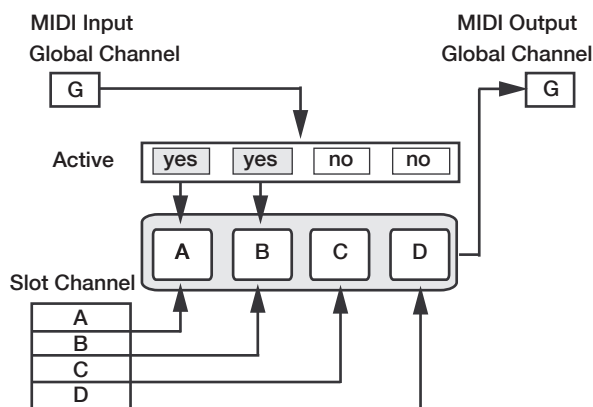

The global channel acts just like playing on the keyboard. The individual slot channels give multi timbrality. MIDI output is always sent on the global channel.

Slot Handling

The Slot buttons, labelled A to D, are used to set the Slot focus, and the active state of the Slots.

To change focus to another Slot, simply press that Slot button. If focus is set to an inactive Slot, that Slot will become active, and the others deactivated.

If only one Slot is active, the focused Slot LED will be lit. When several slots are active, the focused Slot LED will be flashing, and the other active slots will have their LEDs lit.

A layer is created by pressing several Slot buttons at once. You can also hold one of the Slot buttons pressed, then tap another Slot button to activate / deactivate it.

Split

By creating a Split point, the keyboard is divided into two zones, where the lower zone (the left part) plays on Slot A and B, and the upper on Slot C and D. Create a Split Point by holding Shift + Split and pressing the note on the keyboard where you want the Split Point.

Solo

If you double-tap on a Slot button, that Slot enters Solo mode. The other Slots are temporarily deactivated and any audio from them is muted. The Solo mode is indicated with a single flashing Slot LED. Press any Slot button to exit Solo mode and return to the previous state.

Multi Focus

By using Multi Focus, Slot focus can be set to multiple Slots simultaneously. Any changes that are made on the panel then affect all the focused Slots. To turn Multi Focus on, simply press Shift + Multi Focus and all active slots become focused. The focused Slots are indicated with flashing Slot LEDs.

Program Handling

The A1 handles two different program entities; Programs and Performances. The memory contains 400 Programs divided into 8 banks, and 200 Performances divided into 4 banks.

Programs

A Program contains parameter settings for a single synthesizer Slot. A program can be loaded into any of the Slots.

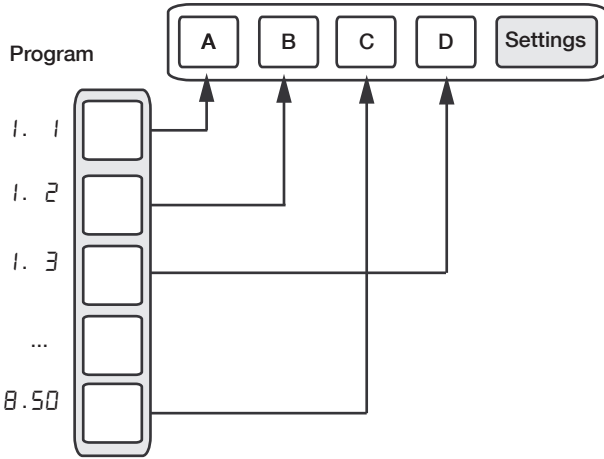

A Program contains parameter data for a single slot.

Performances

A Performance contains parameter data for all four Slots at once. The parameter data for each slot is stored in the Performance – it is not a reference to a Program. Furthermore the Performance contains settings about Slot Focus, Slot Activation, Hold, Split On/Off, Split Point, Keyboard Octave Shift and Multi Focus.

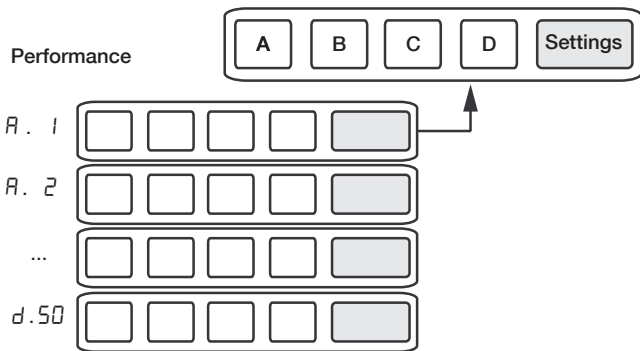

A Performance contains parameter data for all four slots and common settings.

Performance Mode

The Perf Mode button is used to cycle between Performance Mode and Program Mode.

When in Performance Mode the Slot LEDs are green and the display shows the current bank as a letter: "A", "B", "C" or "D".

In Program Mode, the Slot LEDs are red and the bank is shown as a single digit "1" to "8".

Program Mode and Performance Mode have separate Slot buffers. This means that the changes to you make in Performance Mode, will not affect the Slots in Program Mode, and vice versa.

A Performance is useful not only to create layers, but to load four Slots at once. You can then quickly change between these sounds with the press of a button instead of using the Program Dial.

Loading

To load from memory, simply turn the Program Dial. When in Performance Mode entire Performances are loaded and all Slots are affected. In Program Mode only the focused Slot is loaded, leaving the others untouched.

A Performance can be built from existing Programs by loading separate Slots in Performance Mode. Load the Slot by pressing and holding a Slot button, and turning the Program Dial. The Program is then loaded into the selected Slot, not affecting the others. The program focus for that Slot is stored in the Performance as an indication to where that sound came from.

Storing

Storing works exactly as loading, but the other way around. In Performance Mode all four Slots and their common settings are stored to Performance Memory. In Program Mode, only the focused Slot is stored to Program Memory.

To store a sound, press Shift + Store. The location to where the sound will be stored in Memory will flash on the display. Change the store location by turning the Program Dial. The sound in that location is temporarily loaded so that you can hear what you are about to overwrite. Confirm the store operation by pressing Shift + Store again. While selecting the store location you can change between Performance and Program Mode. This is very useful to store all Slots as a Performance, or to store one Slot in a Performance as a Program.

Details about storing for the first time can be found in the Getting Started chapter on page 9.

Copying Slots to a Performance

If you have added several slots together with the Lead A1 in Program mode, a Performance can be easily created with this selection. Hold Copy and press Perf Mode to copy the slots and their settings to a Performance. The display will show the current performance bank and two dashes "- -" to alert you that this performance have not yet been stored.

Copying a Performance to Program

It is possible to copy all the individual Slots in a Performance, to become a multi-slot selection in Program mode. While in Performance Mode, hold Copy and press Perf Mode. The Lead A1 will switch from Performance to Program mode, with all the Slot settings as they were in the Performance.

5 Morph

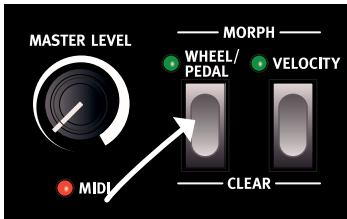

1. Hold a morph button...



2. ...turn a knob from here to here.



3. Use the Mod Wheel to Morph the parameter within that range.



4. Adjusting the parameter setting moves the Morph range.

Morphing

Morphing allows you to be creative in your sound design, and is all about being able to control virtually any important sound related parameter, in real time from the two Morph sources: the Modulation Wheel & Control Pedal and the velocity of the keyboard.

There are 22 available continuous parameters that can be Morphed. This gives you plenty of real-time control possibilities. A Morph is very simple to set up and use, and all Morph assignments that you make are stored with the program or performance.

Many, if not all of the factory programs have morph assigned parameters. If a program uses a Wheel or velocity Morph, the green Morph indicators on the panel will be lit to indicate this.

A Morph Source controls the range from the parameter's original position in the program, to a position you define when you set up the Morph.

This means that you can control a very small range on one parameter at the same time as you control a very large range on another parameter. One parameter can be controlled clockwise, and another parameter can be controlled counter clockwise.

The Morphs

Let's look at the Morph Sources:

Wheel/Control Pedal

This allows you to use the Modulation Wheel or incoming MIDI CC 01 messages and/or a control pedal as the Morph Source.

- The bottom position of the Modulation Wheel and/or control pedal represents the parameters original setting.
- The top position of the Modulation Wheel or control pedal represents the parameters morphed setting.

💡 *If the control pedal is set to control the overall volume of the Nord Lead A1, in the System Menu, the wheel and incoming MIDI CC11 messages will be the Morph source. In addition to this, if Wheel Mode in the System menu is set to Vibrato, incoming MIDI CC11 will be the only Wheel/Pedal Morph source.*

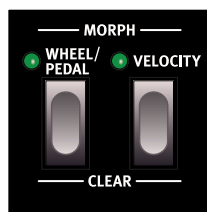

Velocity

This Morph source uses the Note Velocity from the Nord Lead A1 keyboard and from any incoming MIDI messages.

- A key velocity of 1 represents the parameters original setting.
- A key velocity of 127 represents the parameters maximum morphed setting.

Assign a Morph source to a parameter

- 1 Hold a Morph Source button.
- 2 Move the knob of the parameter you wish to control with the Morph Source. Turn it to the setting you want as the maximum Morphed setting.

The selected parameter's green LED will indicate that a Morph is active.

- 3 Release the Morph Source button.

When the Morph source is operated, the parameter's setting will change accordingly and influence the sound.

If the original setting of a parameter is changed after a Morph is setup, the Morph range will not be affected, but it will "move" to reflect the new initial setting of the parameter.

Morph parameters

A Morph can control most of the continuous parameters. Each one of these have a green LED next to its knob:

Morph Destinations			
Arpeggio Rate	Glide	LFO Rate/Time	LFO Clk Div
Mod Env Attack	Mod Env Decay	Mod Env Release	Osc LFO Amt
Osc Modenv Amt	Osc Ctrl	Filt LFO Amt	Filt Modenv Amt
Filter Freq	Filter Res	Filter Drive	Amp Env Attack
Amp Env Decay	Amp Env Release	FX Rate/Amt*	Output Level
Arp Clk Div	Delay Tempo*	Dly Clk Div*	Delay Dry/Wet*
Reverb Dry/Wet*			

❗ ** FX Rate/Amt, Delay Tempo, Delay Clock Div., Delay Dry/Wet and Reverb Dry/Wet can not be Morphed with velocity.*

Editing Morphs

Edit a parameter's Morph range:

- Hold the Morph Source button and turn the destination knob to a new position.

Clear all parameters assigned to a Morph Source:

- Hold Shift and press the Morph Source button that is to be cleared.

Clearing one parameter from a Morph:

- Hold the Morph Source button and turn the parameter knob to its original position. The green parameter Morph LED will be switched off.
- Double-click on a Morph button to latch the Morph, then hold Shift and turn the knob of the parameter you wish to clear.

Copy and paste a Morph setup

- Hold Copy and press the Morph button that is to be copied to the virtual clipboard. "CPY" will be shown in the display. Hold Shift and Paste, then press the destination Morph button. "PSt" will be shown in the display.

Morph Programming Latch

Morphs can be latched, making it possible to lift your finger off the Morph button while setting up the Morph. It provides a great overview that can simplify setting up and adjusting multiple Morph Destinations at once.

- 1 Double-click on one of the Morph Source buttons.

The Morph Source button flashes continuously, and green LEDs on the panel will show any of the parameters that are assigned to this Morph source.

- 2 Operate a parameter that you want to be Morphed.

Press any of the Morph Source buttons to exit Morph Latch Mode.

6 Mutator, Randomize & Like



Mutator

The Nord Lead A1 Mutator is a great and easy-to-use tool to spark the creative process by creating totally new or slightly changed sounds.

Executing the Mutation

- 1 Hold Shift and press Mutate Sound.

The Nord Lead A1 Mutator uses probability and degrees of preservation, together with some secret smartness. The Mutation will use the sound in the focused Slot as the reference or starting point. If a Mutation is executed more than once without you changing any setting on the panel, it will return to, and use that same starting point for each new Mutation. Turn a knob or press a switch if you want an edited or Mutated sound to become the new starting point.

💡 If Multi Focus is enabled, the Mutation will be executed on all the active Slots.

Some parameters are never changed by the Mutator process: Output Level, all Arpeggio and Reverb parameters and Mono/Legato.



Randomize

The Randomize option is a totally random process that does not consider any current or previous programs, music styles, or fashions. Any setting to any parameter can appear, you should not be surprised if a randomized program needs a little bit of adjustment before it can be used for such mundane things as chords or melodies.

- 1 *If Mutator Protect in the System Menu is set to On, you need to confirm your intentions by pressing Execute, or by hitting Mutate- or Randomize Sound two times.*



Mutate Morph

The Mutator and Randomize features in the Nord Lead A1 can be used to create Morphs.

- 1 Hold the Morph Wheel button (or latch the Morph by double-tapping on the Morph button) and press Mutate Sound (without Shift). Several Morph settings will be added to the original sound, as indicated by the green LEDs that lights up on the Panel. If effects are turned off they will be turned on but with rate and dry/wet mix set to 0 as a starting point for the wheel morph.
- 2 Move the Modulation Wheel to hear the result. The original sound is heard when the Mod Wheel is set to 0, the Morphed sound is heard when the Mod Wheel is moved to its maximum.

The Mutator can be applied to Velocity Morphs as well, but will not affect the effect section. The original sound will be heard when you strike the keys with a velocity of 1, the fully Morphed sound when the velocity is 127.

If the Oscillator LFO Amount, Oscillator Mod Env Amount and the Oscillator Control parameters are all set to 0, the Morph Mutation will be able to change the Oscillator Configuration.

- 1 *If Osc Config is set to the Amplitude Modulation or Detune configurations, the configuration will not change.*

Randomizing a Morph is done in a similar fashion, but by pressing the Randomize Sound button instead. This will create a “wilder” result.

Like

- 1 Hold Shift and press Like.

The Like button lets you save programs or entire performances to the Like memory. The Like memory acts like a scratchpad that can be used during the creative process so save sounds that you might want to keep. Performances and programs have separate Like memories, with 50 locations each. When you have reached the 50th Like location, the next Like will overwrite the content in the 1st location. The Like memory is temporary and will be cleared when the Nord Lead A1 is powered off.



Program Likes

Pressing Like when Program Mode is active, will save the sound in the focused slot to the Program Like memory.

- ❗ *Using Like when Multi Focus is active will de-activate Multi Focus, leaving the previously focused single Slot active and save this Slot in the Like memory. The other Slots will retain any edits you made using Multi Focus.*

Performance Likes

Pressing Like when in Performance Mode, will save the entire performance to the Performance Like memory.

- ❗ *If a program or a performance is identical with what was previously saved in the Like memory, it will not be saved again.*

Select a Like to Store

- 1 Press Shift + Store to store a Like that you wish to keep.
- 1 Find a location by turning the Program Dial and press Shift + Store a second time to store the sound.



The Like memory browser becomes available when a program or performance is Liked, indicated by the initial letter "L" in the display. Browse through the Liked sounds by turning the Program Dial. Press Store if you want to permanently store the liked sound to one of the regular memory locations, or just press Exit to leave the Like memory browser.

7 Panel Reference

Master Level

The Master Level knob controls the overall amplitude for the audio outputs - the line level outputs and the headphone output. The knob's physical position indicates the output level and is not stored in a Program or Performance.

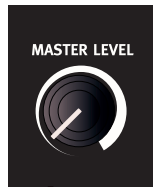

💡 *If you need to adjust the output level in individual programs, use the Output parameter in the upper right area on the panel. The setting of that control is stored.*

MIDI LED

The MIDI LED will indicate incoming MIDI messages by briefly lighting up. Short LED flashes indicates that MIDI messages are received but not used in any way by the Nord Lead A1. Longer flashes are indications that the MIDI messages are actually recognized. This applies to messages on MIDI channels that are in use, CC messages that will change Nord Lead A1 parameters, etc..

Morph

Morphs are used to gradually change one or several parameters with the Morph Controls - the keyboard velocity and the Modulation Wheel and Control pedal - while you are playing.

Hold a Morph button and turn a knob to set the Morph controller, the parameter destination and the range of the Morph control.

For a detailed description on how to use Morphs, please look at page 13.

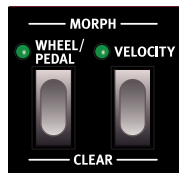

Program/Value Dial

Turn the Program/Value Dial to select programs or performances.

When any of the Menus are entered, the Program Dial is used to select the menu functions and to change settings.



The Program Dial is endless, though the array of parameter settings are not. Once you reach the first or last possible setting, turning the Program Dial further will have no effect.

💡 *The Program Dial has an accelerator feature; when operated swiftly you scroll through values in larger increments.*

LED Display

The LED display will show which program or performance is active. Menu functions, menu settings, confirmation of executed actions and parameter values are also displayed when appropriate.

Performance Mode/Execute

Pressing the Perf Mode button will toggle between Program and Performance Mode. Programs are shown in the LED display as a two or three digit number between *1. 1* and *8.50* and the Slot LEDs will be red. Program mode is typically used to play with one Slot, one program at a time.



Performances can use up to 4 slots with 4 simultaneous programs in various combinations - splits, layers, keyboard controlled and MIDI input. Performances are indicated by initial letters "P", "b", "c" or "d" followed by a number from 1 to 50 with green Slot LEDs.

💡 *Hold a Slot button and turn the Program Dial to load another program in that Slot.*

Commands and actions - the Store command, Mutator, Initialize, Randomize and MIDI actions that are found in the Menus - that needs confirmation will be indicated by flashing characters in the display. Press Execute to confirm or to start the action or the process.

Store

Store is used when program or performance settings are to be stored in the Nord Lead A1 memory. Read more about the Store procedure on page 9.

Copy/Monitor

Use this feature to Copy settings to be pasted to new destinations, and to monitor individual parameter settings. Hold Copy and press a Morph or a Slot button.



Copies can be made from Morphs and entire Slots (complete Programs). A copy can be pasted several times, the content of the clipboard is kept until another copy is made or the Nord Lead A1 is turned off. A selection of active Slots can all be copied to a Performance, and a Performance can be copied to Program mode. Read more about this on page 12.

"[PY]" (followed by a number or letter when appropriate) will be displayed when a Morph or a Slot is copied. A parameter's value is shown in the display when it is copied.

Paste

Hold Shift + Paste and select a destination to paste the copied data. "P5E", or "P5" and the Slot (or the value of the single parameter) will be displayed.

Monitor

You can use this feature to monitor the value of a setting in the display, by holding this button and turning a knob.

Slot A - D

The Nord Lead A1 has 4 Slots, labeled A to D. Each Slot can be loaded with one program. Slots can be used one by one in Program Mode or together in Performance Mode.

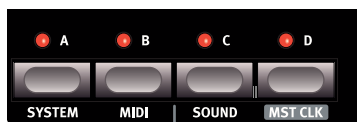

- Slot LEDs are red in Program Mode, green in Performance Mode and yellow when you enter the Menus.

The Slot buttons can be used to quickly change from one program in one Slot to another Program in another Slot.

To change the active Slot, simply press a single Slot button. To activate additional Slots, hold one Slot button and press the buttons of the additional Slots you wish to activate. Any combination of the four slots is possible, by pressing two or more Slot buttons at the same time.

Deactivate a Slot

Hold an active Slot button and press another active Slot button to deactivate that other Slot.

Panel Focus

The Slot with a flashing LED has the Panel Focus, it is this sounds that will be edited from the panel. To move the Panel Focus, press another button of an active Slot.

Multi Focus

Multi Focus allows you to change settings simultaneously on all the active Slots in a performance (or a multi-Slot scenario). Press Multi Focus and all the active Slot's LEDs will flash. Any parameter change you make on the panel will affect all the Slots.

Active Multi Focus will be stored in a performance.

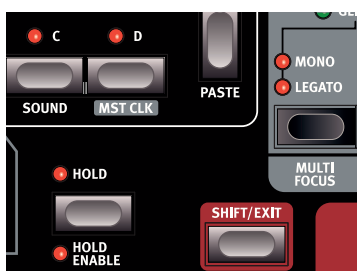

Soloing a Slot

Double-click on an active Slot in a multi-slot selection to solo this Slot. Press on any of the other Slot buttons to exit.

Incoming MIDI

If a Slot has been assigned a MIDI channel in the MIDI menu, incoming MIDI on this channel will control this Slot, even if it is not active on the Nord Lead A1 panel. This makes it possible to have quite advanced MIDI setups with some Slots being controlled from the A1 keyboard, and other Slots from external MIDI units. Read more on this in the MIDI Chapter on page 32.

System - MIDI - Sound

Shift and System, MIDI or Sound buttons enters the menus where global settings are made. Read more about the menu settings on page 30.

Master Clock

Shift + Slot D displays the tempo of the Master Clock. Change the tempo by turning the Program Dial, or by tapping repeatedly on the Mst Clk button. The tempo can be set from 30 to 300 BPM.

Four consecutive taps are needed to make a tempo change, more taps can be used after those initial four. The first tap will show the current

tempo in the display, the three taps after the first will present a dot that moves across the bottom of the display to indicate the position of the taps in the 4/4 beat.

Octave Shift

Transpose the sound in the focused Slot with the Octave Shift buttons. **Range: -2, -1, 0, +1, +2 octaves.**

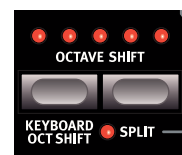

No octave shift is applied when the center LED is lit. This parameter will be stored in a Program.

- LEDs to the right of the center LED will indicate a shift upwards.
- LEDs to the left of the center LED will indicate a shift downwards.

- Keyboard messages from the Nord Lead A1's MIDI Out will not be transposed.

Keyboard Octave Shift

Keyboard Oct Shift transposes the keyboard in octaves for the entire instrument. The LEDs will be in an inverted state to indicate that you are in the Keyboard Octave Shift mode. The setting of the Keyboard Octave Shift will be stored in a performance.

- MIDI Note messages at the MIDI output will be transposed.

Split

Split divides the keyboard in two part. Slots A and B are controlled by the lower part, Slots C and D by the upper part.



Setting the Split point

Hold Shift + Split and press a key on the keyboard to set the split point. The key you press is indicated in the display and will become the lowest key of the upper range. The Split parameter and the split point will be stored in a performance.

Hold

Use Hold together with Hold Enable to create notes and chords with infinite length, they will continue to sound when keys are released. This can be used to create drones or hold arpeggios. The Hold parameter will be stored in a performance.



Hold Enable

A program must have Hold Enable active to be held with the Hold feature. The separate Hold Enable feature makes it possible to enable and disable Hold on selected programs in a performance. The Hold Enable parameter will be stored in a program.

Shift/Exit

Shift is used together with other buttons or knobs to access additional functions. The name of the additional functions are printed below the buttons and knobs.



Pitch Stick

The Pitch Stick is used to bend notes. The range is set with the Bend Range parameter, see page 19.



Modulation Wheel

The Modulation Wheel can add vibrato if the Vibrato Voice Mode setting is set to "Wheel" and/or act as a Morph Control, to control one or several parameters while you perform. The Modulation Wheel will transmit MIDI CC 01.

Arpeggiator

Use the arpeggiator to automatically play a repeated sequence of notes based on notes or chords you play on the keyboard.



Arpeggio Run

Starts and stops the arpeggiator.

Arpeggio Rate

The tempo of the eight note arpeggio is set by the Rate knob, with a range from 16 BPM to "F5", which is "very fast".

Arpeggio Mst Clk

Hold Shift and turn Rate to lock the arpeggiator to the Master Clock. Rate will then be used to select the time divisions.

Arpeggiator Divisions

Division	Description
2, 4, 8, 16, 32	The straight divisions range from 1/2 notes to 1/32 notes.
2t, 4t, 8t, 16t	The t indicates the triplet divisions.

Arpeggio Range

The arpeggiator has a range from 1 to 4 octaves.

Arpeggio Directions

The arpeggio directions are: Up (no LED), Down (DN), Up/Down (U/D) and Random (Rnd).

Panic

If notes would ever sustain indefinitely during a performance, press Shift and Panic. This will execute an internal All Notes Off command, and reset incoming MIDI CC messages.

Voice Mode

Unison

Unison stacks de-tuned voices "on top of each other," in the same fashion as on the classic analog polyphonic synthesizers. Unison will position voices left and right with various strengths in the stereo panorama.

- Unison 1 is two slightly detuned and panned voices.
- Unison 2 is four slightly detuned and panned voices.
- Unison 3 is four voices with a stronger detuning and panning.



Mono

Mono makes the Slot monophonic, only one note at a time will be heard. The envelopes will be re-triggered for each new note you play.

Legato

Legato is another monophonic mode. The envelopes will not be re-triggered if you play legato, they will continue in their present phase.

Legato is when you play a key without releasing a previously played key.

Glide

Glide can be used to set the time interval for the pitch to glide from one note to a new note, when Mono or Legato is active. With a setting of zero the pitch will change instantly.

If Legato is active, Glide will only occur if you play legato.

Multi Focus

Multi Focus allows you to change settings simultaneously on all the active Slots. Press Multi Focus and the active Slot's LEDs will flash. Any parameter change you make on the panel will affect all the Slots. Active Multi Focus can be stored in a performance. Press a Slot button to exit.

Bend Range

Bend Ranges can be different for each program and can be set to a maximum of +/- 48 semitones. There are also two settings with different ranges for the upward and downward bend.

Press Shift + Bend Range repeatedly. The first press will display the current setting, each consecutive press will increase the bend range one step at a time.

Hold Bend Range and turn the Program Dial to scroll through the available settings.

Bend Range	Description
Off	Pitch Bend is disabled.
1 - 12, 24, 48	Pitch Bend range in semitones.
-12, -24	Pitch Bend range is 2 semitones for upward bends, and 12 or 24 semitones for downward bends.

Vibrato

The Dly1 and Dly2 settings add a delayed vibrato, the delay time being 0.5 and 1.0 seconds. The vibrato rate and the depth of the delayed vibrato is set in the Sound Menu.

When Wheel is selected, the depth of the vibrato is controlled by the Modulation Wheel and incoming MIDI CC 01.



Init Sound

Pressing Shift + Init Sound provides you with a neutral starting point for all parameters if you want to begin programming a sound from scratch.

You need to confirm your intentions by pressing Execute or pressing Init Sound again.

Low Frequency Oscillator (LFO/ENV)

The Low Frequency Oscillator (LFO) produces a waveform that can be used to create cyclic modulations to the oscillators and filter. The Nord Lead A1 LFO can also be set to an envelope mode. The amount of modulation is set with the LFO amount knobs in the oscillator and filter sections. The LFO can be synchronized to the Master Clock.



i The LFO in the Nord Lead A1 is monophonic.

Rate/Time

The Rate knob sets the frequency of the LFO.
Range: 0.03 to 523 Hz.

LFO Master Clock (Mst Clk)

Enable Mst Clk (Shift + Rate/Time knob) to synchronize the LFO to the Master Clock. The Rate knob will be used to control the time division.

Division	Description
4b, 2b, 1, 2, 4, 8, 16, 32, 64	The straight divisions range from 4 bars to 1/64 notes.
4bt, 2bt, 1t, 2t, 4t, 8t, 16t, 32t	The t indicates the triplet divisions, from 4 bars to 1/32 notes.

LFO Waveform Selector

Waveform	Description
	Square Used for abrupt modulation changes, suitable for trills, distinct tremolos, etc.
	Sawtooth Used for linear ramp type modulations.
	Inverted Sawtooth Inverted linear ramp.
	Triangle Suitable for natural vibrato effects, also good for classic pulse width modulation.
S/H	Stepped Random Recreates a stepped random modulation.

Envelope

The cyclic behavior of the LFO can be changed to behave as an envelope. Press Shift + LFO waveform selector to enable this feature. The Time control will depend on the selected waveform.

i When the LFO is used as an envelope, it is polyphonic.

Waveform	Description
	A gated envelope, the Time control sets the gate-time.
	Decaying envelope, the Time control sets the decay time.
	Attack envelope, the Time control sets the attack time.
	A/D envelope, the Time control sets the envelope duration.
S/H	S/H random values that are generated for each key. The Rate/Time knob sets a time lag from one value to the next.

LFO Modulation Polarities

The modulation of the LFO is unipolar, with a few exceptions. Pitch and PW modulations with triangle and S&H waveforms are bipolar.

Modulation Envelope

The polyphonic Modulation Envelope is a ADR/ASR envelope that can be used to modulate the oscillators and/or the filter in the Nord Lead A1.

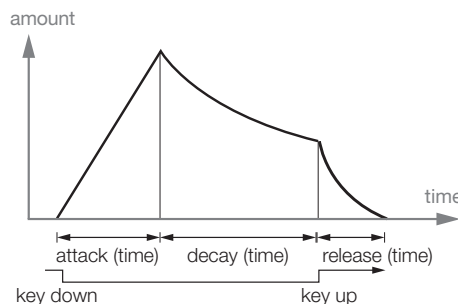

Attack

Attack is the time it takes for the modulation envelope to reach the maximum modulation level. This envelope phase begins when you press a key. **Range: 0.45 ms to 45 s.**

Decay

The Decay begins after the attack phase is completed. It is the time it takes for the modulation envelope to drop back down to zero again.

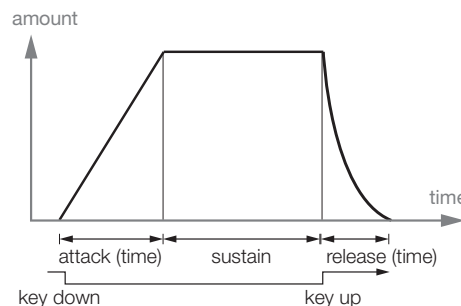

If Decay is turned fully clockwise, the decay will be infinite, acting as a sustain level. **Range: 3.0 ms to 45 s, Sustain.**

Release

The Release phase of the envelope begins after you have released the key. This setting determines how long it should take for the envelope to drop to zero after the key is released. The release phase may start anywhere during the envelope's other phases, it will begin as soon as a key is released as shown in this illustration. **Range: 3.0 ms to 45 s.**

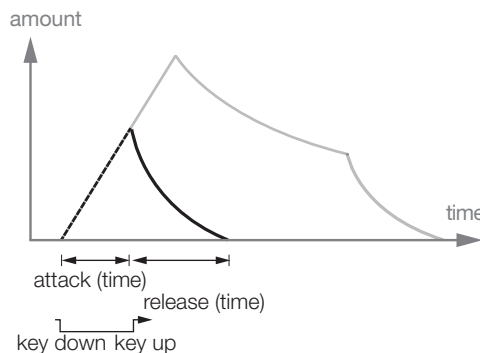

Inverted Envelope

Hold Shift and turn the Decay knob to invert the polarity of the Modulation Envelope.

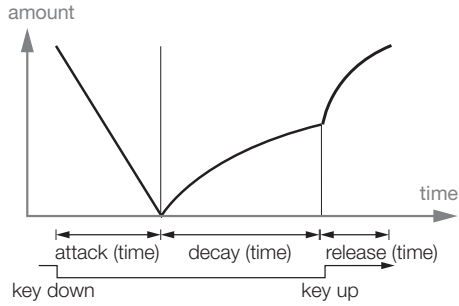

Env Vel

Hold Shift and turn the Release knob to make the amplitude of the Modulation Envelope velocity sensitive.

Oscillators

The oscillator is the foundation of the sound in a synthesizer. It produces the waveform with its harmonic content. This important property of the sound can then be shaped and/or modulated.

The Nord Lead A1 features a newly developed Wave Engine with unique Oscillator Configuration Shortcuts utilizing one or two oscillators. Start with an Oscillator waveform from a choice of multiple analog and digital waves, select an Oscillator Configuration Shortcut - Pitch, Detune, Shape, Sync, FM, AM, Dual Osc or Noise - and use the Osc Control knob to adjust the settings of the configuration.



Panel Analog Waveforms

		Shape Mode		
		Shape = 0.	Shape = 5.	Shape = 10.
Pulse				
Saw				
Triangle				
Sine				

Extended Analog Waveforms

		Shape Mode		
		Shape = 0.	Shape = 5.	Shape = 10.
A1				
A2				
A3				
A4				
A5				
A6				
A7				

i A6: Exponential Saw. A7: Exponential Square.

Fixed Pulse Waveforms

i Fixed Pulses will keep the width even if the pitch changes.

		Shape Mode		
		Shape = 0.	Shape = 5.	Shape = 10.
P1				
P2				
P3				

Drawbar Organ Waveforms

01	808000000	"Second".
02	880000000	"Third".
03	888000000	"Jimmy Smith".
04	888800000	"Blues".
05	888800008	"Gospel".
06	808808008	"Church".
07	800008888	"Squabble".
08	888888888	"Full Organ".
09	888888888 +++++	"Full Organ Plus".

Bells and Tines

b1	Inharmonic spectra of vibrating metal bars.
b2	Harmonic version of vibrating metal bars.
b3	Spectra from a vibrating bar with one fixed end.
b4	Metal marimba bar.
b5	Inharmonic spectra of tubular bells.

Digital

d1	Saw spectra with random phase.
d2	Square spectra with random phase.
d3	Spectra with only even partials.
d4	Spectra with only every third harmonic.
d5	Spectra with only every fourth harmonic.
d6	Spectra with only every fifth harmonic.
d7	Triplets.
d8	Ice.

Electric

E1	Electric Piano 1.
E2	Electric Piano 2.
E3	Clavinet 1.
E4	Clavinet 2.

Formants

F1	Voice "AAA".
F2	Voice "EEE".
F3	Voice "OOO".
F4	Voice "YYY".
F5	Voice "AO".
F6	Voice "AE".
F7	Voice "OE".

Oscillator Configuration

The Oscillator Configuration allows you to re-configure the connections and in some cases, the actual functions of the oscillators in the Nord Lead A1. These shortcuts together with the Oscillator Control parameter can make drastic changes to the timbre of the oscillators. The configurations vary from quite basic with a single oscillator, to complex setups with two oscillators, wave-shaping or FM algorithms. There are 8 types of Oscillator Configurations.

Single Oscillator Configurations

Pitch

The Pitch configuration is a single oscillator, where its pitch can be modulated with the Mod Envelope, the LFO or set or Morphed by the Osc Control.

Single oscillator setups can be great for clean bass sounds, and nice, sharp solo sounds.



Shape

This single oscillator configuration uses the Osc Control to act as a powerful waveshaper. The shaping of the Panel Analog, Extended Analog and Fixed Pulse waveforms uses a traditional waveshaping method, the other waveforms are changed with a spectral shaping process.



Sync

This configuration is a Oscillator Hard Sync setup with a "hidden" sync oscillator, that recreates the classic oscillator sync sounds from the 70s. Oscillator Sync results in a multi resonant spectrum with moving peaks.



Noise

One oscillator and a white noise source. The Osc Control sets the mix between oscillator 1 and the noise source.

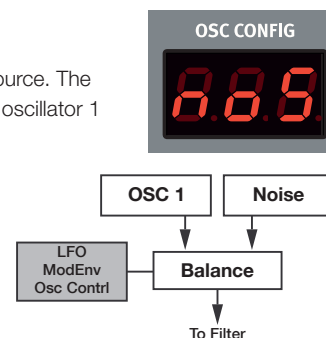

Dual Oscillator Configurations

Detune

Detune is a configuration with two oscillators where oscillator 2 can be either slightly detuned or tuned in semi tone intervals. If the Panel, Extended Analog or Fixed Pulse waveforms are used, both oscillators will use the same waveform. When any other waveform is used, oscillator 1 will use a sine wave fundamental. Osc Control adjusts the pitch of oscillator 2 with a wide range from a gentle detune to a 60 semitone interval.

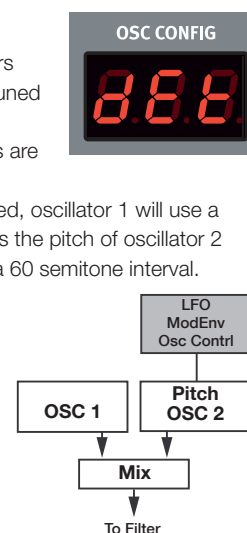

Sine, Tri, Saw and Pulse Mix



There are four Mixed configurations that add a second oscillator with a waveform and a harmonic partial relationship to oscillator 1. The Mixed configurations are presented with the waveform and a numerical value of a harmonic partial in the Oscillator Configuration display. Here are a few examples:

5R.1	Sub (1 octave down).
5R.1	Nominal = Oscillator 1
5R.2	1 octave up.
5R.3	3:rd harmonic.
5R.4	2 octaves up.
5R.5	5:th harmonic.
5R.6	6:th harmonic.
5R.7	7:th harmonic.
5R.8	3 octaves up.

i The waveform of oscillator 1 is the one specified with the Waveform Dial.

Modulation Configurations

FM (Frequency Modulation)

This is a classic 2 operator FM synthesis configuration where oscillator 1 is the carrier and oscillator 2 is the modulator. The frequency of oscillator 2 is set by the Osc Config dial, with a frequency range of -12 to +48 semitones, relative to oscillator 1.

FM synthesis is a powerful tool for generating a very complex spectra from a simple waveform. FM synthesis can create both harmonic and inharmonic sounds depending on the frequency relation between the modulator and the carrier. The most famous FM synthesizer is the DX7 from the mid 1980's.

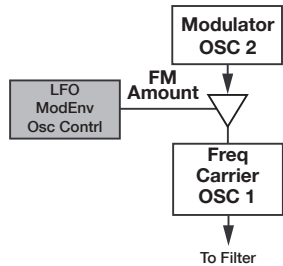

AM (Amplitude Modulation)

Oscillator 1 will be amplitude modulated by a sine wave from oscillator 2. Osc Control sets the frequency of oscillator 2.

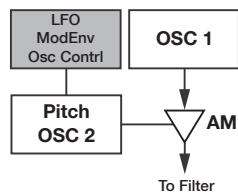

Amp Envelope

The Amp envelope is a polyphonic ADR/ASR envelope, used to control how the sound amplitude or level changes over time. By modulating the amplifier with an envelope, the sound can be given its basic "shape". In fact, the "volume shape" is one of the most important factors in how we identify the sound. By setting up a proper amplifier envelope you can make a sound "soft", "hard", "plucked" "static" etc.

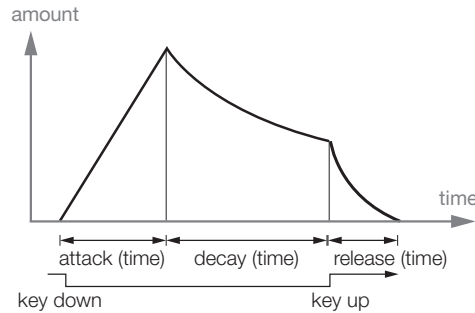

Attack

Attack is the time it will take for the envelope to go from zero to the maximum amplitude as soon as a key have been pressed. **Range: 0.5 ms to 45 s.**

Decay

Decay is the time it takes for the envelope to drop down to zero after the attack phase has been completed. When Decay is turned fully clockwise, it will not drop down at all, but remain at the full sustain level. **Range: 0.5 ms to 45 s, Sustain**

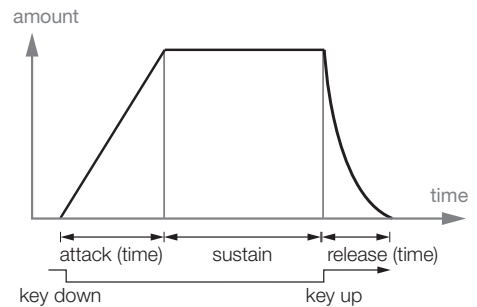

Release

The Release phase of the envelope begins after you have released the key. This setting determines how long it should take for the envelope to drop to 0 after the key is released. The release phase may start anywhere during the envelope's other phases. It will begin as soon as a key is released. **Range: 3.0 ms to 45 s.**

Env Vel

Press Shift and turn the Release knob to enable Envelope Velocity. This makes the amplitude velocity sensitive.

Filter

The Filter is one of the most important components to create the overall timbre of the sound. The harmonic content that the oscillators produce can be shaped with the filter and the filter frequency can be modulated with several functions. The Nord Lead A1 features a selection of traditional synthesizer low pass, band pass and high pass filters and two unique emulations of filters from two vintage synthesizers, the Low pass M and the Low pass TB.

i The two vintage filters are not just an emulation of their characters, we have modeled the resonance, the internal distortion and the envelope characteristics of the original units as well.

The six filters share the filter parameters: Freq controls the cutoff frequency, Resonance controls the filter resonance. Drive adds some overdrive distortion inside the actual filter and the Modulation Envelope Amount allows you to control how much the filter would be shaped by the Modulation Envelope.

Filter Frequency (Freq)

Filter Frequency is used for setting the cutoff frequency point - where in the frequency range the filter begins to attenuate frequencies. **Range: 14 Hz - 35 kHz.**

The Image illustrates three different Filter Frequency settings using a low pass filter. The area to the right of the sloping line represents the part of the sound that is filtered out.

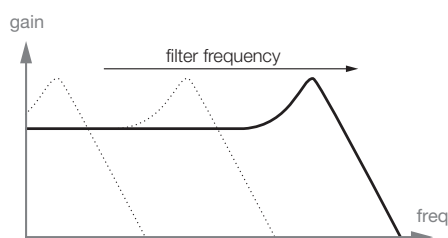

Filter Resonance

Filter Resonance is used to emphasize frequencies around the Filter Frequency. If you are using a low pass filter, increasing resonance will emphasize frequencies around the set Filter Frequency and de-emphasize the rest of the frequency spectrum. Further raising the Filter Resonance will make the sound resonant to a point where the filter adds a ringing quality to the sound. Some of the filters will even start to oscillate at high resonance settings.

LFO Amount

LFO Amt controls the amount of filter frequency modulation from the LFO.

Modulation Envelope Amount

Mod Env Amt controls the amount of filter frequency modulation from the Modulation Envelope.



Keyboard Tracking (KB Track)

Keyboard Tracking allows the filter frequency to track the pitch of the keyboard.

This is related to basic acoustics; if you raise the pitch of a waveform, the amplitude of the high harmonics will also increase. If the filter cutoff frequency is nontracking, the sound will be perceived as getting less bright the higher up the keyboard you play.

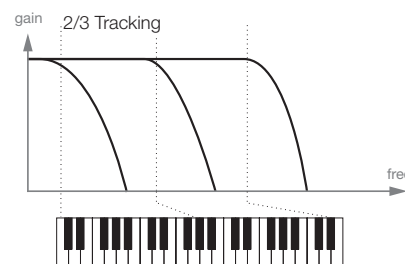
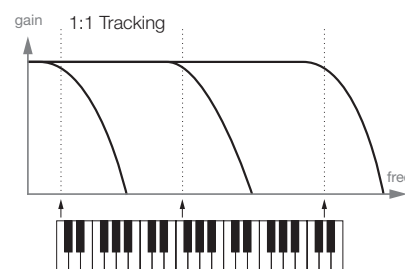

- With KB Track off, the Filter Frequency cutoff is not controlled from the note you play.
- With KB Track at the 1/3 setting, the cutoff frequency will track the keyboard in a 1:3 relationship, play one octave higher and the cutoff frequency will move by 1/3 of an octave.
- With KB Track at the 2/3 setting, the cutoff frequency will track the keyboard in a 2:3 relationship, play one octave higher and the cutoff frequency will move by 2/3 of an octave.
- With KB Track at the maximum setting of 1, the cutoff frequency will track the keyboard in a 1:1 relationship.

Drive

Drive adds a distortion after the filter with a range that spans from gentle to quite rude. The Drive On LED will be lit when Drive is enabled.

💡 Try the drive with high filter resonance settings.



Filter Type

Select one of the six available filter types.

LP 12, 24

A low pass filter attenuates frequencies above the filter frequency setting. The number indicates the slope, how steep the filter would become above the filter frequency. A 24 dB/octave filter has a steeper slope than a 12 dB/octave.

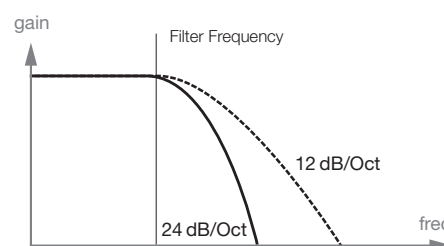

LP M

Low Pass M is an emulation of an original transistor filter from the famous Mini. This groundbreaking and much-loved filter design was created and patented in the 1960's by Dr Robert A. Moog. The Low Pass M is a four-pole, 24 dB/octave, resonating low-pass filter. The resonance on the Low Pass M is one detail that makes it stand out, leaving more of the low end of the signal than on a traditional 24 dB/octave low-pass filter. We have not only analyzed the frequency characteristics and the resonance, but the internal distortion and the envelope response (for both filter and amp envelopes) as well.

LP TB

Low Pass TB is an emulation of the diode ladder filter from the vintage Roland TB-303 from 1982. This is a four pole, 24 dB/octave design but it does not sound anything like the similarly spec'd LP M. The Low Pass TB has a nice, quirky character to it and will not go into self oscillation like the other low pass filters, when resonance is turned up high. Another important feature in this filter is that a set resonance level will drop quite a bit if the filter frequency is lowered.

BP

A band pass filter lets frequencies at the filter frequency pass, while frequencies above and below the filter frequency will be attenuated. The Lead A1 band pass filter has a 12 dB/octave slope on each side of the filter frequency.

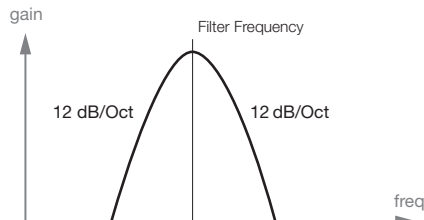

HP

A high pass filter filter will attenuate frequencies below the filter frequency, frequencies above the cutoff will not be affected. The slope of the high pass filter is 24 dB/Oct.

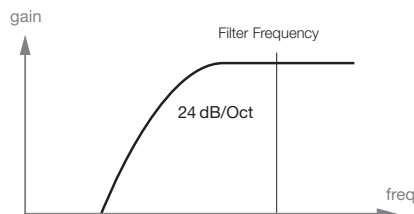

FX

The Nord Lead A1 has a collection of great effects that can add anything from very subtle to quite drastic changes to the sound. The Rate/Amount knob controls rate or amount depending on the effect used. Turn the knob to "Off" and the effect will be bypassed.

Flanger

The flanger effect is produced by mixing two identical signals together, one signal delayed by a small and gradually changing amount, usually shorter than 20 milliseconds. The delayed signal is also fed back into the signal path. This produces a swept comb filter effect, with a nice swooshing sound. The flanger in the Nord Lead A1 is modeled after a vintage MXR™ unit.

Phaser

The phaser effect is created by splitting the audio signal into two paths. One path passes through a filter that alters the phase. The amount of change in phase depends on the frequency. When the signals from the two paths are mixed together, frequencies that are out of phase will cancel each other out, creating the phaser's characteristic notches. The phaser in the Nord Lead A1 is modeled after a vintage MuTron™ unit.

RM

Ring Modulation is an effect that multiplies an audio signal with another. In this case the audio signal from the filter/amplifier will be multiplied with a sine wave. The frequency of this sine wave is controlled by the Rate/Amt knob. At low settings you get a tremolo effect, higher settings

will produce some quite drastic harmonic spectra.

Chorus

A Chorus is achieved by taking an audio signal and mixing it with one or more delayed, pitch-modulated copies of itself. The pitch of the added copies are modulated by an LFO. This makes the chorus effect similar to that of a flanger, except that it is created with longer delay times, giving it a more gentle sound. The output of the Chorus in the Nord Lead A1 is in stereo.

Ensemble

The Nord Lead A1 Ensemble effect is modeled after a vintage Eminent organ effect. The very characteristic sound comes from feeding the audio into three separate, modulated delay lines, that are cross-connected with each other. The output of the Ensemble in the Nord Lead A1 is in stereo.

Drive

The Drive amplifies the audio signal until it distorts in the same fashion as an overdriven tube style amplifier. This creates that typical asymmetric soft clipping with the warm-sounding, even-order harmonics that sounds so nice on almost any sound.

Mutate Sound

Mutate Sound will create an automatic edit of the current, focused sound. For a more detailed description of the Mutator, please look at page 15.

Delay

The Delay can add anything from short, slapback echoes to long, loop type repeats. Since the delay can be synchronized to the Master Clock, it can be a creative component in rhythmic sounds, together with the arpeggio and the LFO.

The Delay has 4 feedback levels, a Dry/Wet control and adjustable tempo. The Delay tempo can be set manually or synchronized to the Master Clock and the repeats can be alternating between the left and right output.

The Delay features an optional analog mode that behaves like an "old school" delay when changing the delay tempo on the fly.

Tempo

The Tempo knob sets the time interval between the repeats. If the Delay is synchronized to the Master Clock tempo, Tempo will set the divisions. **Range: 20 ms to 1500 ms.**

Division	Description
2, 4, 8, 16, 32, 64	The straight divisions range from half notes to 64ths.
4d, 8d, 16d	The dotted divisions will add an additional half of the note value. 4d equals one 1/4 and a 1/8th etc...
2t, 4t, 8t, 16t, 32t	The t indicates the triplet divisions.
4s, 8s, 16s,	The s indicates the swing divisions.

i Divisions are ordered according to their perceived tempo. This is why the "4d" will be before of "2t", "4s" is before of "4", and "4t" is after "4" etc..

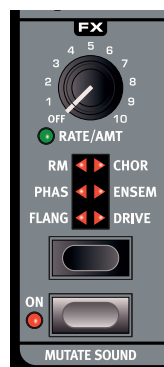

Tap Tempo

Tap repeatedly on the Tap Tempo button to set the tempo for the delay. You need four consecutive taps to set a tempo, but the tempo can be fine tuned with additional taps after those initial four.

Mst Clk

Enable Mst Clk to synchronize the delay to the Master Clock.

Feedback

Feedback allows you to select the number of repeats. There are 4 settings to choose from, ranging from one repeat (no active LEDs), to several (both the 1 & 2 LEDs are lit).

Ping Pong

Ping Pong will place every other delay repeat alternatively in the left/odd and right/even audio output.

Dry/Wet

Sets the amount of the delay in the audio signal.

 *Dry/Wet is routed in a send configuration, it can be Morphed to "completely dry" without affecting already present delay repeats.*

Sound Menu Delay Mode

The Sound Menu Delay Mode setting can be set to normal or analog. This determines if the delay should change the pitch on sounding repeats in the fashion of an analog delay, if the Delay Tempo is adjusted. When set to Normal, the pitch does not change.

On/Off

Turns the delay on or off.

Randomize Sound

Randomize Sound will do exactly what it says: it will generate a sound by randomly changing most of the parameters. This feature can be put to good use, to create those sounds that are outside the box. For a detailed overview of the Randomize Sound feature, please look at page 15.

Output

Level

Output Level sets the amplitude. The setting of this parameter is stored in the Program.



Pan

Use Pan (Shift + Level) to position the sound in the stereo panorama. The Pan LED will be lit as soon as a sound is panned to either side of the center.

Reverb

The Reverb effects simulates natural sound reflections in various acoustic environments.

Dry/Wet

The Dry/Wet knob controls the balance in amplitude between the unprocessed (dry) and processed (wet) signal.

 *Dry/Wet is routed in a send configuration, it can be Morphed to "completely dry" without affecting already present reverberations.*



Reverb Select

The Reverb button selects the type of reverb effect:

Setting	Description
Room	Small reverberation with room ambience and a fast decay.
Stage1	Medium reverberation with stage ambience, medium decay and a mellow character.
Stage2	Medium reverberation with stage ambience, medium decay and a bright character.
Hall1	Full reverberation with a hall ambience, slow decay and a mellow character.
Hall2	Full reverberation with a hall ambience, slow decay and a bright character.

On/Off

Turns the Reverb on or off.

Like

The Like button lets you save programs or entire performances to the Like memory. Performances and programs have separate Like memories, with 50 locations each. When you have reached the 50th Like location, the next Like will overwrite the content in the 1st location. The Like memory is temporary and will be cleared when the Nord Lead A1 is powered off. For a detailed overview of the Like feature, please look at page 15.

Note Trig (Nord Lead A1R)

Press Shift + Note Trig to trigger a note on the Nord Lead A1R. The actual note to be triggered can be selected by turning the Program Dial when holding this button combination.

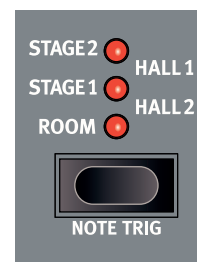

8 Master Clock



Master Clock

The Master Clock is a feature that can synchronize three functions in the Nord Lead A1 to a common tempo; the arpeggiator, the LFO and the delay. The Master Clock tempo has a range between 30 and 300 beats per minute. This tempo can be set manually with the Program Dial, or by tapping to a beat by using the Slot D/Mst Clk button.

Master Clock is global and reaches across all four Slots, making it possible to create a synchronized performance with several individual rhythmic parts. Master Clock is activated for each individual function that you wish to be synchronized, by enabling “Mst Clk” in that section.

With Mst Clk enabled, the Rate or tempo knob of the individual functions will be used to set the Time Division. The divisions can be set to straight divisions like quarter notes, eighth notes, or triplets, dotted and swing divisions.

Division	Description	Available in
4b, 2b, 1	4 bar, 2 bar & 1 bar divisions.	LFO
2, 4, 8, 16, 32, 64	Half notes up to 32ths divisions, with an additional 64ths for the Delay and LFO.	Arp, Delay, LFO
4d, 8d, 16d	The dotted divisions will add an additional half of the note value. 4d is a quarter note and an eight etc..	Delay
4bt, 2bt, 1t,	4 bar, 2 bar & 1 bar triplet divisions.	LFO
2t, 4t, 8t, 16t, 32t	Half note to 32nd triplet divisions.	Arp, Delay, LFO
4s, 8s, 16s,	Quarter note to 16th swing divisions.	Delay

Divisions are ordered on account of their perceived tempo which is why triplet quarter notes are found between the dotted eights and the swing eights when you select the Delay divisions.

External Sync

The Master Clock will automatically lock to the tempo of an incoming MIDI Clock. The tempo of the incoming MIDI Clock will be shown in the display if the Mst Clk button is pressed.

- ❗ If you try and manually change the Master Clock tempo when it is being synchronized to a MIDI Clock, “E.Cl” will be shown in the display.

Arpeggio with Mst Clk

Let’s try out a few things with the arpeggio and the Master Clock.

- 1 Hold Shift and turn the Arpeggio Rate knob. The Mst Clk LED lights up.
- 2 Hold down a key or a chord and press Arpeggio Run. The Run LED lights up and the arpeggio starts running.
- 3 Press Shift + Hold Enable and then Hold to hold the notes you’ve played.
- 4 Turn the Arpeggio Rate knob, to set the division of the arpeggio. Hear the arpeggio speed up or down as the divisions change. Find the quarter note division (“4”) and leave it there.
- 5 Hold Shift + Mst Clk and turn the Program Dial to set a tempo. You can also tap the Mst Clk button while holding Shift to set a tempo. Four taps (or more) are needed to determine a tempo.
- 6 Feel free to adjust the filter and envelope settings to a short, nice sound. I’ll wait here. Oh, you’re already done? Great, let’s move on.

You can change the range of the arpeggio with the Range selector, from one to four octaves, but let’s stick with 1 for now. Shift + Range acts as the arpeggio direction selection. Press repeatedly to listen to the various directions.

Synced Delay repeats

Keep the arpeggio running and we'll add more things.

- ① Turn both Delay knobs (Tempo & Dry/Wet) fully counterclockwise, press Feedback to light up the "1" LED.
- ② Turn on the Delay, hold Shift and press the Delay Tap Tempo button to enable the Master Clock for the delay.
- ③ Turn the Delay tempo knob to select the Master Clock "8d" division and turn up the Dry/Wet mix until you hear the delay repeats.

The arpeggio will play quarter notes, and the delay repeats will be dotted eighth notes (the first repeat will "move" the following repeats by half an 1/8 note).

Sync the LFO

- ④ Let's add a synchronized LFO sweep. Enable the LFO Master Clock sync by holding Shift and turning the LFO Rate/Time knob.
- ⑤ Select the Triangle waveform.
- ⑥ Have the LFO modulate the filter by turning up the Filter LFO Mod Amount knob a bit
- ⑦ Turn the LFO rate to select "2b" (2 bars) and turn up the Filter LFO Amount knob a bit close to the 12 o'clock position. If the LFO Amount doesn't seem to do anything, try closing the Filter Frequency a bit.

There are now quarter notes playing from the arpeggiator, with delay repeats that are synced to dotted 8 notes, and the LFO that opens up the filter once every 2 bars.

- ⑧ Hold the Mst Clk button and turn the Program Dial. The tempo changes and the three rhythmic things we have running in this example all change simultaneously to reflect the new tempo.

❗ *A tempo setting will be stored in a performance.*

Across the Slots

There is one Master Clock tempo for each performance. All Slots can be in perfect sync with each other.

Sound Menu Kbd Sync

The Sound Menu setting "Mst Clk Kbd Sync" determines if the Master Clock should be reset when you press a key. This type of reset can have a hard or a soft behavior, the softer would allow for note changes slightly ahead of the beat. The Kbd Sync feature can also be turned off, letting the Master Clock run free.

9 Nord Sound Manager

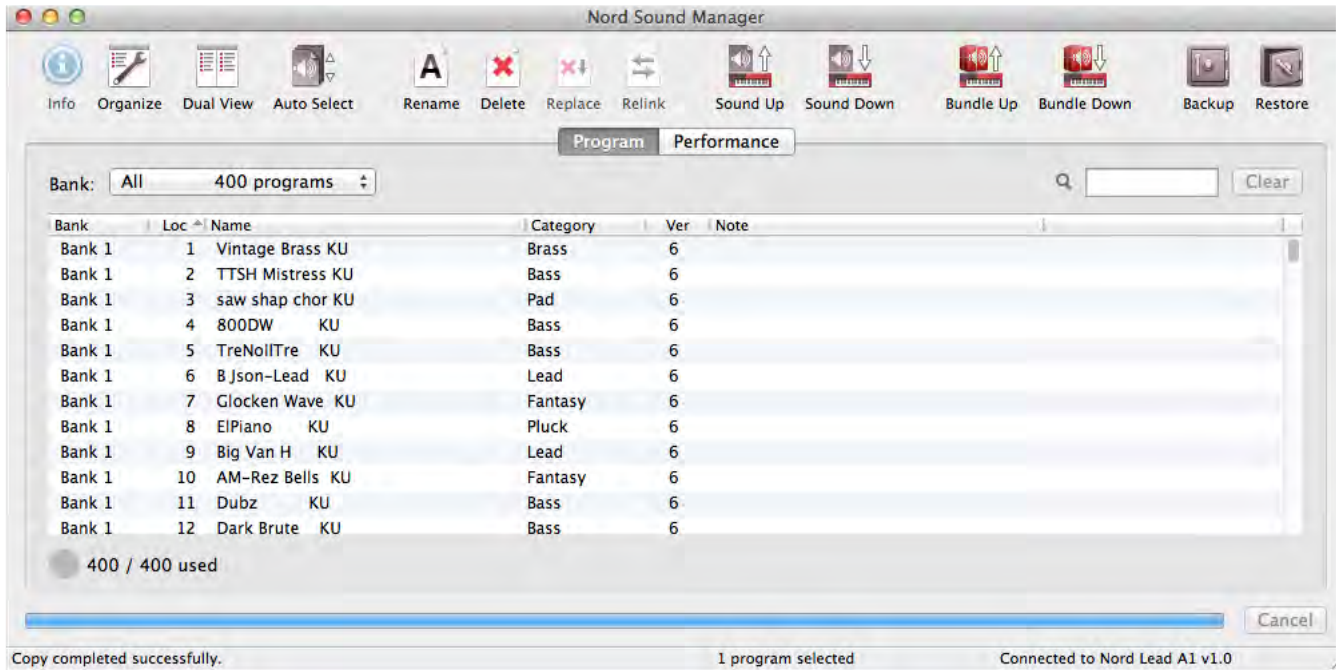

Nord Sound Manager is a free application that allows you to organize the various memory areas, the partitions in the Nord Lead A1. It is also used to download performances or programs to the Nord Lead A1 or to upload any of these items from the Nord Lead A1 memory to the computer hard drive. The Nord Sound Manager provides access to various methods to download the sounds to the Lead A1 and a function to backup and restore the entire Nord Lead A1 memory.

The Nord Sound Manager, the Manager User Manual and USB drivers and instructions on how to install these are available at the www.nordkeyboards.com website in the Download area.

System requirements

The Nord Sound Manager is compatible with computers running Mac OSX 10.4 or later, Windows XP, Vista, Windows 7 and Windows 8. If you run the Nord Sound Manager on a Windows computer, you also need a Clavia USB Driver of version 3.02 or later installed. This driver will be automatically installed by the Sound Manager Setup application.

10 The Menus

Any settings that you change in the System, MIDI or Sound menu will take immediate effect on a global basis, and will be stored until you change them the next time. Enter the menus by pressing and holding Shift and the System, MIDI or Sound button (Slot A - C buttons). The A-C LED above the buttons will turn yellow and start blinking. Select a function by turning the Program Dial and change the setting by holding Shift and turn the Program Dial at the same time. Exit the menus by pressing a second time on any Slot button.

System Menu

1 - Memory Protect

The Memory Protect setting determines if Programs and Performances can be stored to the Nord Lead A1 memory or not. The setting is On when the Nord Lead A1 leaves the factory.

- ❗ *System, MIDI and Sound menu settings are not protected.*

Range: On (default), off

2 - Transpose

This setting can transpose the pitch of the Nord Lead A1 up or down in semitone steps.

- ❗ *The MIDI output will not be transposed.*

Range: +/- 6 semitones (default = 0).

3 - Fine Tune

This setting fine tunes the pitch of the Nord Lead A1.

Range: +/- 50 cent (default = 0).

4 - Sustain Pedal Polarity

Change the polarity of a connected sustain pedal, in case the functionality of the pedal is reversed. The Auto setting will determine what polarity a connected pedal has.

Range: Auto (default), CL - Close, OP - Open.

5 - Wheel Mode

The Modulation Wheel can be set to control both Morph and Vibrato, or as an exclusive Vibrato control.

Range: L1 Morph + Vibrato (default), L2 Vibrato.

6 - Ctrl Pedal Mode

A connected Control pedal can be used to control the Nord Lead A1 volume or as a Morph Controller.

Range: P1 Volume (default), P2 Morph.

7 - Ctrl Pedal Type

Different models of control pedals have different specifications (resistance, offset and linearity). The most commonly used pedals are pre-configured in the Nord Lead A1, select the type you use.

Range: R5 (Roland EV-5, default), R7 (Roland EV-7), Y7 (Yamaha FC-7), K0 (Korg EXP-2 & XVP-10), Ft (Fatar & Studiologic VP/25)

8 - Ctrl Pedal Gain

Add some gain to the output of a connected Control pedal if it does not reach the maximum level. Operating a connected control pedal will display the output level from 0 to 100.

Range: 1 - 10 (default 1).

9 - Mutator Protect

When Mutator Protect is On, you need to confirm your intentions by pressing Execute before the actual Mutate Sound or Randomize Sound takes place.

Range: On, Off (default)

A B C D - Slot Output Routing

Route the Slots to the audio outputs of the Nord Lead A1. Slots can be routed to output pairs (1-2 and 3-4), or single outputs.

- ⚠ *Outputs 1 & 2 are routed to the headphones.*

Ranges: 12 (default), 34, 1, 2, 3, 4.

MIDI Menu

G - Global MIDI Channel

The Global MIDI Channel transmits all keyboard, pedal and panel actions. It can also be used as a receiving channel.

Range: 1 - 16, Off (default = 1).

A, B, B, D - Slot MIDI Channel

Set individual MIDI Channels for the Slots when they should respond to MIDI events on certain incoming MIDI Channels.

Range: 1 - 16, Off (default A = off, B = off C = off, D = off).

t - Soft Thru MIDI Channel

Incoming MIDI note on/off data that is received at either the 5-pin or the USB MIDI on the Soft Thru Channel, will be re-routed to the 5-pin MIDI OUT connector.

Range: 1 - 16, Off (default = 10).

1 - Local Control

Local disables or enables the connection between the keyboard and panel and the actual Lead A1 synthesizer. Local On is the default setting. Local Off is useful when an external sequencer is used and the keyboard and panel is only used to transmit MIDI, which the sequencer then routes back to the synthesizer.

Range: On (default), Off

- ❗ *Local defaults back to On every time the Nord Lead A1 is powered on.*

2 - Control Change (CC) Mode

Control Change Mode specifies how the front panel's knobs and buttons are handled in the MIDI communication with MIDI Control Change messages. The options are either send or receive, or both, or if these messages should be ignored.

Range: Sr (send & receive - default), r (receive only), S (send only), Off

3 - Program Change Mode

Program Change Mode specifies how the Nord Lead A1 handles MIDI Program Change messages.

Range: Sr (send & receive - default), r (receive only), S (send only), Off

4 - Pitch Bend Mode

Pitch Bend Mode specifies how the Nord Lead A1 handles the Pitch Bend stick and incoming pitch bend MIDI messages.

Range: Sr (send & receive - default), r (receive only), S (send only), Off

5 - Send CC

Dump all Program parameters of the currently focused Program as MIDI Control Change messages. Press Execute to begin the transmission.

6 - Dump One

Dump One makes a MIDI System Exclusive transmission of all the parameters of the currently active Program or Performance. Press Execute to begin the transmission.

7 - Dump Program Bank

Dump Program Bank makes a MIDI System Exclusive transmission of all the parameters, for all of the 99 Programs or Performances in the current Bank. Press Execute to begin the transmission.

In the MIDI chapter on page 33, there is a description on how the Nord Lead A1 receives a Sys Ex dump.

Sound Menu

1 - Mst Clk Kbd Sync

Master Clock Keyboard Sync On will reset the Master Clock when a key is played. The Soft option is a more gentle approach, depending on when in the beat, the key is played.

Range: Off, SF (Soft, default), On.

2 - Delay Mode

Delay Mode Analog will change the pitch on sounding repeats, when the Tempo is adjusted with the Delay Tempo knob. When set to Normal, the pitch will not change.

Range: nO (Normal), An (Analog = default).

3 - Vibrato Rate

The rate of the Vibrato.

Range: 4.00 - 8.00 Hz (default = 6 Hz).

4 - Vibrato Amount

The amount of the Vibrato when the delayed vibrato modes are used.

Range: 0 - 50 cent (default = 12 cent).

11 MIDI

Nord Lead A1 MIDI operation

The Nord Lead A1 is designed to be very flexible in a MIDI setup. You can use it as a keyboard to control its internal sounds and other hardware or software sound sources. It can also be used as a set of individual sound engines to be played/controlled by external MIDI units such as a sequencer.

There are two fundamental methods of operation when using the Nord Lead A1 in a MIDI setup. You can use the Global MIDI Channel or individual Slot MIDI Channels. These methods differs a little bit in their flexibility and in what you can achieve.

Lead A1	MIDI IN	MIDI OUT
Global MIDI	✓	✓
Slot MIDI	✓	

Keys you play on a Nord Lead A1 keyboard, and any tweaks that you do on the Lead A1 panel will generate MIDI messages on the Global Channel.

A Slot MIDI Channel is only receiving MIDI messages.

❗ *Whenever the text in this manual refers to a “keyboard”, the meaning in the description is also relevant for a external MIDI controller.*

MIDI Settings

MIDI Channel selections, settings on how the Lead A1 should handle Program Change, Pitch Bend, Control Change messages and other MIDI related settings are made in the MIDI Menu.

Global MIDI Channel

By using the Global MIDI Channel, all MIDI notes and Control Change messages can be transmitted and/or received on a single MIDI channel.

MIDI that enters the Nord Lead A1 on the Global MIDI channel will play all the Slots that are active. If a Performance includes layers and/or splits, or actions with the Morph controls, those aspects will be reproduced in the same way as if you played on the keyboard itself.

Slot MIDI Channels

By using the individual Slot MIDI Channels in the Nord Lead A1, you have individual control of the Slots, for notes as well as for parameters. This can for example be used as a multitimbral setup, controlling 4 individual sound sources from a sequencer.

⚠ *A Slot does not have to be active in a Performance, it will always respond to incoming MIDI on its MIDI Channel. This makes it possible to control selected Slots from the keyboard, and other Slots from other external sources.*

Sequencing: Global MIDI Channel

Connect the Nord Lead USB connection (or the 5-pin MIDI In and Out) to a computer/MIDI interface/sequencer. Set the sequencer track to all Channels or MIDI Channel 1, which is the default Global MIDI channel in the Nord Lead A1.

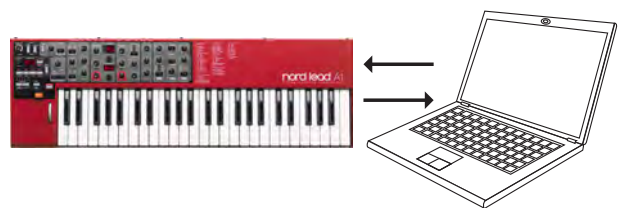

Play on the keyboard and record the performance. Any controllers that you use – Morphs, pedals etc. – will also be transmitted as MIDI messages.

Recording parameter changes

There are more parameters available in the Nord Lead A1 Slots than there are available MIDI Control Change numbers. This means that the Slot buttons on the panel will be used to set the transmitting and receiving Slot focus of panel generated CC messages. This allows you to record and receive parameter changes on the Global MIDI Channel.

If you want to make parameter changes on more than one Nord Lead A1 Slot at the same time, the Slot MIDI Channel approach will be more suitable.

Sequencing: Slot MIDI Channels

Program or record the notes to tracks in the sequencer, tracks that are set to the Slot MIDI Channels. Keyboard and panel actions from the Nord Lead A1 will be transmitted on the Global MIDI Channel. Local may be turned Off, to avoid double triggered sounds.

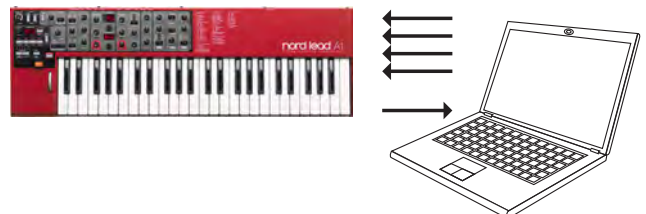

Overdub tracks to record any parameter changes by making these on the Nord Lead A1 panel, or from other MIDI devices set to control the Nord Lead A1.

Continue with the next track, set to another Slot's MIDI Channel.

Control Slots with another keyboard

Use a Performance with some of the Slots controlled from the Lead A1 itself and other Slots from an external keyboard or sequencer, set to corresponding Slot MIDI channel(s). Active Slots will be controlled from the A1 keyboard, inactive Slots are controlled from external units.

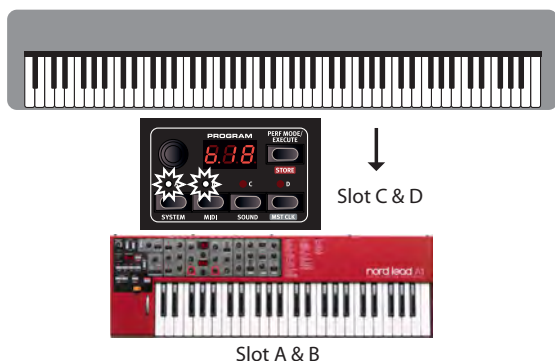

Message types

Program Changes and Bank Select

Program Change messages are transmitted on the Global MIDI channel and are recognized on the Global and/or the Slot MIDI Channels. Bank Select messages (CC00, CC32) are used to select the 8 program banks (CC00, value 0 + CC32 values 0-7) or the 4 performance banks (CC00, value 0 + CC32, value 0-3) when Performance Mode is active. Bank Select messages should be immediately followed by a Program Change message when you wish to select a bank from an external unit.

The Slots will respond to incoming Program Change messages on their individual Slot MIDI Channels.

Incoming Program Change messages on the Global MIDI Channel will change the performance, if Performance Mode is enabled.

- ❗ *Incoming Program Change on the Global MIDI Channel will change programs on the focused Slot if Performance Mode is not enabled.*

If you do not want the Nord Lead A1 to transmit or respond to Program Change messages, this can be turned off in the MIDI Menu.

Control Change messages

Most of the parameters on the Nord Lead A1 panel will generate a CC message if operated, and the reception of these messages will change the parameter accordingly. A full list of the parameters and their Control Change number is on page 34.

If you do not want the Nord Lead A1 to transmit or respond to Control Change messages, this can be turned off in the MIDI Menu.

Pedal Control Change

A Control pedal transmits CC7 if it is set to volume in the System Menu and CC11 if it is set to be a Morph source. The sustain pedal transmits CC64.

Volume

The output level of an Performance or an individual Slot can be set by transmitting CC7 to the Nord Lead A1 on the Global, or any of the Slot MIDI Channels.

Pan CC

The position of an Performance or a individual Slot in the stereo panorama can be set by transmitting CC10 to the Nord Lead A1 on the Global Channel, or any of the Slot MIDI Channels.

MIDI Local

If a sequencer is set to echo back incoming MIDI data, this can cause double triggered notes if the Nord Lead A1 keyboard is used. If this occurs, set MIDI Local to Off.

MIDI Thru

A Soft Thru Channel can be set in the MIDI Menu. By doing this, incoming note messages on that channel from the USB MIDI or the 5-pin MIDI Input, will be re-routed through the 5-pin MIDI Out connector.

MIDI Clock

The Nord Lead A1 Master Clock will automatically sync to incoming MIDI Clock.

- ❗ *The Nord Lead A1 does not transmit MIDI Clock messages. If you want to synchronize several units including the Nord Lead A1, an external MIDI Clock source should be used.*

USB MIDI

If you use a computer running Windows XP, Vista, Windows 7 or Windows 8, install the Nord v3.x USB driver to be able to use the MIDI via USB functionality. This driver is available through Windows Update by just connecting the computer to the Internet with the Nord Lead A1 connected at one of the USB ports. The USB driver can also be downloaded from the www.nordkeyboards.com website.

- ❗ *Computers running Mac OSX have a native USB MIDI support for the Nord units. No driver installation is necessary.*

Panic

If notes get stuck during a performance, press Panic. This will reset incoming CC messages and send an All Notes Off message to all Slots.



MIDI Dumps

Transmit settings

Complete Program and Performance settings can be transmitted through MIDI as Controller Change or System Exclusive messages. The transmissions are executed in the MIDI Menu.

A Control Change transmission contains the settings of the single Program in focus and can be used to initialize a sequencer track with Program parameters.

Use System Exclusive to store a Program or a complete Performance on a computer or in a sequencer. A System Exclusive transmission can also contain all the Programs or Performances in a Bank.

Receive Programs or Banks

Make sure that the MIDI Channel on the transmitting device matches the Global (or Slot) MIDI Channel on the Nord Lead A1 and start the transmission on the computer/sequencer.

Single Programs will be placed in the Nord Lead A1 edit buffer, you need to Store these if you want to keep them.

The currently active Program Bank in the Nord Lead A1 will be overwritten if a System Exclusive package of a complete Bank is received.

MIDI Controller list

These are the MIDI Control Change numbers used for the Nord Lead A1 parameters.

- Buttons that control “on/off” functions have a Controller value of “0” at the “off” position and a value of “127” at the “on” position.
- Buttons that step through various possibilities start with a Controller value of “0” for the “lowest” setting and then increment for each step upwards. The size of the increments depends on how many possible settings there are.

Nord Lead A1 parameter	MIDI CC
Arp Run	90
Arp Tempo/Clk Divisions	9
Arp Master Clock Enable	86
Arp Range	88
Arp Direction	89
Glide Rate	5
Mono Selector	15
Voice Mode Unison	16
Pitch Bend Range	118
Vibrato Select	56
LFO Rate/Clk Divisions	19
LFO Waveform Selector	20
LFO Master Clock Enable	2
LFO Envelope Selector	34
Mod Envelope Attack	26
Mod Envelope Decay/Sustain	27
Mod Envelope Release	28
Mod Envelope Invert	38
Mod Envelope Velocity	29
Osc LFO Modulation Amount	68
Osc Mod Envelope Amount	69
Osc Control	31
Osc Waveform Selector	30
Osc Configuration	33
Filter LFO Modulation Amount	48
Filter Mod Envelope Amount	43
Filter Frequency	74
Filter Type	44
Filter Keyboard Tracking	46
Filter Drive	47
Filter Resonance	42
Amp Envelope Attack	73
Amp Envelope Decay	36
Amp Envelope Release	72
Amp Envelope Velocity	35
FX Amount	55
FX Selection	53
FX On/Off	52
Delay Tempo/Clk Divisions	78
Delay Master Clock Enable	51
Delay Feedback	79
Delay Ping Pong	100
Delay Amount	76
Delay On/Off	99
Output Level	71

Nord Lead A1 parameter	MIDI CC
Pan	10
Reverb Amount	98
Reverb Selector	96
Reverb On/Off	97
Octave Shift	17
Hold	58
Hold Enable	54
Slot Focus	119
Slot Enable	115
Volume Pedal (transmits if enabled as Volume in System menu)	7
Ctrl Pedal (transmits if enabled as Morph in System menu)	11
Mod Wheel	1
Wheel/Pedal Morph (incoming CC)	11
Sustain Pedal	64
Bank Select MSB	0
Bank Select LSB	32

MIDI Implementation Chart

Function		Transmitted	Recognized	Remarks
Basic Channel Default Channel		1 - 16 1 - 16	1 - 16 1 - 16	Indiv. channels for Slot A, B, C & D
Mode	Default Message Altered	Mode 1, 3 X *****	Mode 1, 3 X	
Note Number	True Voice	0-127	0-127	
Velocity	Note ON Note Off	O, v= 1 - 127 X	O, v= 1 - 127 X	
After Touch	Key's Channel	X X	X X	
Pitch Bender		O	O	
Control Change		O	O	See MIDI CC on page 34
Program Change True#		O, 0-98	O, 0-98	Bank Sel: CC00, CC32
System Exclusive		O	O	
System Common	Song Pos Song Sel Tune	X X X	X X X	
System Realtime	Clock Commands	X X	O	
Aux Message	Local on/off All notes off Active Sense Reset			
Number	True Voice			

Mode 1: Omni On, Poly - Mode 2: Omni O, Mono - Mode 3: Omni Off,
Poly - Mode 4: Omni Off, Mono - O = Yes - X = No

12 Appendix

Specifications

General

- 49-key octave velocity sensitive keyboard with octave shift buttons (+/-2 octaves).
- 26 voices.
- Keyboard Split with 2 slots for the upper and lower sections.
- Modulation Wheel (keyboard version only).
- Pitch Stick with no dead zone at zero crossing (keyboard version only).
- Programmable Pitch bend range, up to +/- 4 octaves.
- Separate up/down bend range: + 2 semitones, -12 or -24 semitones.
- 1 pedal input for sustain pedal.
- 1 pedal input for expression pedal.

User Interface

- 3 LED displays, 23 knobs, 3 encoders and 20+ buttons for program and performance editing.

Oscillator Section

- Oscillator models of multiple waveforms (traditional analog, extended analog, pulse waveforms, digital waveforms)
- Oscillator Configurations: 8 categories (pitch, detune, shape, sync, amplitude modulation, noise, mix configurations, FM)

Filter Section

- Multi-mode filter with 12 dB/Oct (2-pole) low pass, 24 dB/Oct (4-pole) lowpass and band pass, high pass, Ladder M and Ladder TB characteristics.
- Cut off, Resonance, envelope amount, envelope amount controlled by velocity.
- Filter keyboard tracking can be set to off, 1/3, 2/3 or 1:1.
- Adjustable Filter Distortion.

Modulation Section

- LFO generates a triangle, square, sawtooth or sample and hold waveforms. LFO can be routed to Filter Frequency, and Oscillator Modulation. The LFO rate can be synchronized to the Master Clock.
- LFO can be switched to Env mode with four different characteristics and a sample and hold generator that is manually triggered by keyboard.
- Arpeggiator: Range: 1 - 4 octaves. Modes: up, down, up/down, random. The Arpeggio rate can be synchronized to the Master Clock.
- ADR/ASR envelope, velocity control on/off, inverse envelope on/off.

Amplifier Section

- ADR/ASR envelope, velocity control on/off, gain control.
- Individual panning per program

Performance Section

- Voice modes: Poly, Legato and Mono with Glide, True Unison 1, 2 & 3.
- Four program slots for layering possibilities.
- Effects.
- FX section with Flanger, Phaser, Ring Modulation, Chorus, Ensemble and Drive.
- Delay section with tap tempo, four stages of feedback, ping-pong, dry/wet mix. The Delay tempo can be synchronized to the Master Clock.
- Reverb section with five algorithms (Room, Stage 1, Stage 2, Hall 1, Hall 2).

Memory

- Programs (single sounds): 8 x 50 (400) locations.
- Performances (multi sounds): 4 x 50 (200) locations.

Audio Out

- 4 outputs. Each slot can be assigned to its own output.
- Headphones output.
- High resolution low noise 24 bit DACs.

MIDI Features

- All control knobs and switches send and receive control change messages.
- System exclusive bulk dumps. One program or all programs.
- Master Clock will sync to incoming MIDI clock.
- Soft Thru.

Connections

- 4 Line Level Audio Outputs - ¼", 6,35 mm jacks, unbalanced.
- Stereo Headphone Output - ¼", 6,35 mm stereo jack.
- Sustain Pedal - ¼", 6,35 mm jack. Use a momentary pedal, like e.g., Roland DP-2, DP-6, Yamaha FC-4, FC-5, Fatar VFP1-25 etc.
- Control Pedal - ¼", 6,35 mm TRS stereo jack. Use a Yamaha FC-7, Roland EV-7, Roland EV-5, Korg EXP2 or Korg XVP10.
- USB connector with MIDI capabilities.
- MIDI In & Out - 5 pin DIN connectors.

Included Accessories

- User Manual.
- Power Cord with IEC C14 connector.
- Rack Ears (Nord Lead A1R only).

Dimensions

- Nord Lead A1: 802 x 92 x 260 mm (31.5 x 3.6 x 10.2").
- Nord Lead A1R: 466 x 115 x 169 mm (18.3 x 4.5 x 6.6").

Weight

- Nord Lead A1: 4.85 kg (10.7 lbs).
- Nord Lead A1R: 3,35 kg, 6.6 lbs.

Display Messages

Message	Description
	Storing
<i>Pro</i>	Memory Protected.
	Mst Clk Tempo
<i>E.C.L</i>	Master Clock is synchronized to external MID Clock, tempo cannot be manually set on the Nord Lead A1.
	Mutator, Randomize, Init Sound
<i>mut</i>	Press Execute to Mutate Sound.
<i>rnd</i>	Press Execute to Randomize Sound.
<i>ini</i>	Press Execute to Init Sound.
<i>DE</i>	Mutate/Random/Init process executed
	Copy and Paste related
<i>CP_x</i>	Copy Slot, where x is a, b, c or D.
<i>PS_x</i>	Pasting a copied Slot to a destination Slot (a, b, c or D).
<i>CPY</i>	Copy Velocity/Wheel Morph.
<i>PSt</i>	Pasting a Velocity/Wheel Morph.
<i>5.0</i>	Copy (and Paste) a setting with value 5.0 (0.0 - 10.0).
	MIDI System Exclusive transfers
<i>E.Su</i>	Read/Write Error.
<i>E.Si</i>	Size Error.
<i>E.vE</i>	Version Error.
<i>E.Ch</i>	Check Sum Error.
<i>Pro</i>	Memory Protected.

13 Index

Index

A

Amp Env 23
Amplitude Modulation 23
Arpeggio 19
Arpeggio directions 19
Arpeggio range 19
Attack 23
Audio Connections 37

B

Band Pass 25
Bend Range 19

C

Control Change Mode 31
Control Pedal 8
Control Pedal Mode 30
Control Pedal Type 30
Copy 17
Ctrl Pedal Gain 30

D

Decay 23
Delay
 Feedback 26
 On/Off 26
Delay Mode 31
Detune Configuration 22
Dial 17
Display 17
Dly1 19
Dry/Wet
 Reverb 26
Dump One 31
Dump Program Bank 31

E

Env 20
Envelope 20
Envelope Amount 24
Env Vel 21
Execute 17
Expression pedal 8

F

Feedback 26
Filter 24
 Drive 24
 Frequency 24
 Resonance 24
Fine Tune 30
Focus 9
Freq 24
Frequency Modulation 23

G

Glide 19
Global Channel 31

H

Headphones 8
High Pass 25
Hold 18
Hold Enable 18

I

Init Sound 19
Inv Env 21

K

Kbd Sync 31
KB Track 24
Keyboard Octave Shift 18
Keyboard Tracking 24

L

Layer 9
LED Display 17
Legato 19
Level 26
LFO
 Rate 20
 Waveform Selector 20
Like 26
Local 31
Low Pass 24

M

Master Clock 27
Master Level 17
Memory Protect 30
MIDI
 Connections 8
 Controller 34
 LED 17
MIDI Channel 31
MIDI Menu 31
Mixed Configurations 23
Mod Env 20
Modulation Envelope 20
Mod Wheel 19
Monitor 17
Mono 19
Morph
 Mode 14
 Range 14
Morph destinations 13
Morphing 13
Morph Latch 14
Mst Clk 19, 20, 26
Multi Focus 18
Mutate Morph 15
Mutate Sound 25
Mutator 15

N

Noise 22
Note Trig 26

O

Octave Shift 18
Osc Config 22
Osc Ctrl 22
Oscillator 21
Oscillator Configuration 22
Output 26
 Connections 8
Output Routing 30

P

Pan 26
Panic 19
Paste 17
Pedal Connections 8
Performance Mode 17
Ping Pong 26
Pitch 22
Pitch Bend Mode 31
Program Change 31
Program Dial 17

R

Randomize 15
Randomize Sound 26
Release 23
Run 19

S

Selector buttons 7
Send CC 31
S/H 20
Shape 22
Shift 18
Slot Channel 31
Slot Output 30
Slots 9, 18
Soft Thru 31
Specifications 36
Split 10, 18
Store Button 17
Storing 9
Sustain Pedal 8, 30
Sync Configuration 22
System Menu 30

T

Tap Tempo 26
Transpose 30
Type 24

U

Unison 19
USB Connection 8

V

Velocity 13
Vibrato Amount 31
Vibrato Rate 31
Voice Mode 19

W

Wave 21
Wheel 13

FCC Information (U.S.A.)

1. IMPORTANT NOTICE: DO NOT MODIFY THIS UNIT!

This product, when installed as indicated in the instructions contained in this manual, meets FCC requirements. Modifications not expressly approved by Clavia may void your authority, granted by the FCC, to use the product.

2. IMPORTANT: When connecting this product to accessories and/ or another product use only high quality shielded cables. Cable/s supplied with this product MUST be used. Follow all installation instructions. Failure to follow instructions could void your FCC authorization to use this product in the USA.

3. Note: This equipment has been tested and found to comply with the limits for a Class B digital device, pursuant to Part 15 of the FCC Rules. These limits are designed to provide reasonable protection against harmful interference in a residential installation. This equipment generates, uses, and can radiate radio frequency energy and, if not installed and used in accordance with the instructions, may cause harmful interference to radio communications. However, there is no guarantee that interference will not occur in a particular installation. If this equipment is found to be the source of interference to radio or television reception, which can be determined by turning the equipment off and on, the user is encouraged to try to correct the interference by one or more of the following measures:

- Reorient or relocate the receiving antenna.
- Increase the separation between the equipment and receiver.
- Connect the equipment into an outlet on a circuit different from that to which the receiver is connected.
- Consult the dealer or an experienced radio/TV technician for help.

This device complies with Part 15 of the FCC Rules. Operation is subject to the following two conditions:

- (1) this device may not cause harmful interference, and
- (2) this device must accept any interference received, including interference that may cause undesired operation.

Unauthorized changes or modification to this system can void the users authority to operate this equipment.

This equipment requires shielded interface cables in order to meet FCC class B Limit.

For Canada

NOTICE

This Class B - digital apparatus complies with Canadian ICES-003.

AVIS

Cet appareil numérique de la classe B - est conforme à la norme NMB-003 du Canada.

DECLARATION OF CONFORMITY Compliance Information Statement

Model Name: Nord Lead A1, Nord Lead A1R

Type of Equipment: Digital Synthesizer

Responsible Party: Clavia DMI AB

Address: P.O. BOX 4214. SE-102 65 Stockholm Sweden

Telephone: +46-8-442 73 60

